

vivitek[®] User Manual
Vivid Color, Vivid Life

**DX761Z-UST
DW763Z-UST
DH765Z-UST
Series**

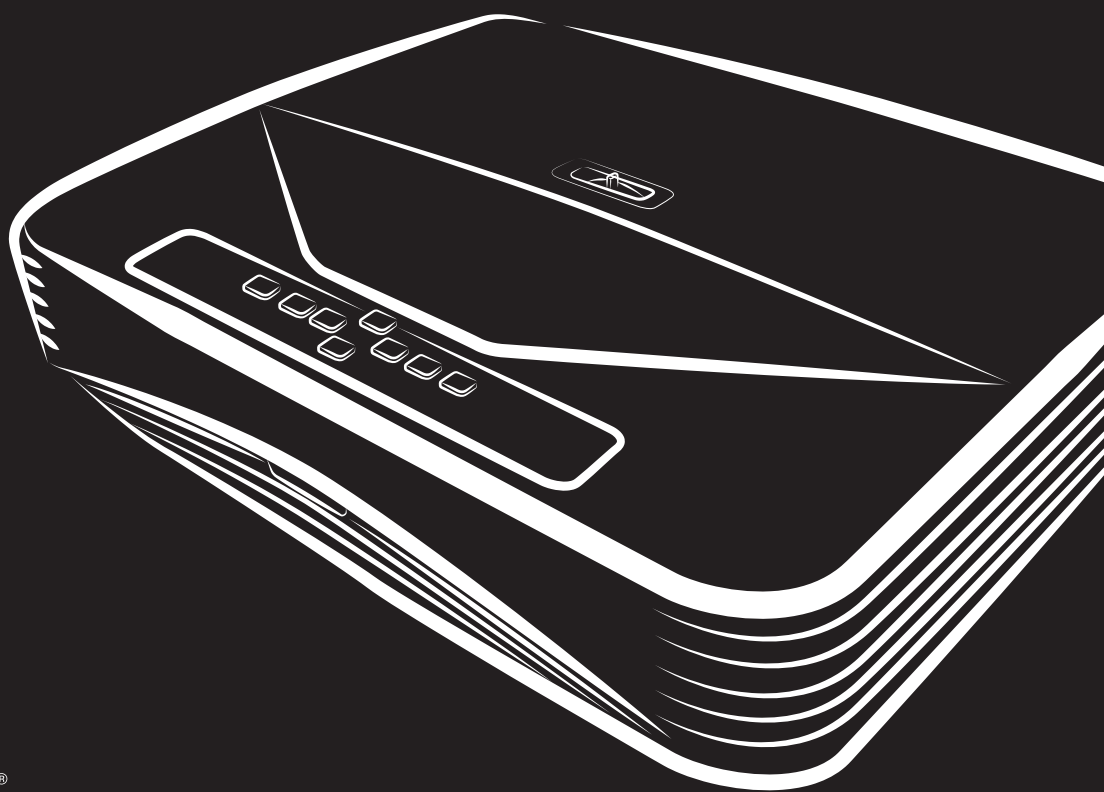

DLP[®]
TEXAS INSTRUMENTS

FCC notice

This equipment has been tested and found to comply with the limits for a Class B digital device, pursuant to part 15 of the FCC Rules. These limits are designed to provide reasonable protection against harmful interference in residential installation. This equipment generates, uses and can radiate radio frequency energy and if not installed and used in accordance with the instructions, may cause harmful interference to radio communications. However, there is no guarantee that interference will not occur in a particular installation. If this equipment does cause harmful interference to radio or television reception, detectable by turning the equipment in question off and on, the user is encouraged to try to correct the interference by one or more of the following measures:

- Reorient or relocate the receiving antenna
- Increase the distance between the equipment and the receiver
- Connect the equipment to an outlet on a different circuit than that which the receiver is connected to
- Or consult the dealer or an experienced radio/TV technician for help.

This device complies with Part 15 of the FCC Rules. Operation is subject to following two conditions:

1. This device may not cause harmful interference, and
2. This device must accept any interference that may cause undesired operation.

Safety instructions

Read all of these instructions before you operate your projector and save for future reference.

1. **Read instructions**
All the safety and operating instructions should be read before the appliance is operated.
2. **Notes and warnings**
All notes and warnings in the operating instructions should be adhered to.
3. **Cleaning**
Unplug the projector from the wall socket before cleaning. Use a damp cloth for cleaning the projector housing. Do not use liquid or aerosol cleaners.
4. **Accessories**
Do not place this product on an unstable cart, stand, or table. The product may fall, causing serious damage to the product.
Keep the plastic packing materials (from the projector, accessories and optional parts) out of the reach of children as these bags may result in death by suffocation. Be particularly careful around the small children.
5. **Ventilation**
The projector is equipped with ventilation holes (intake) and ventilation holes (exhaust).
Do not block or place anything near these slots, or internal heat build-up may occur, causing picture degradation or damage to the projector.
6. **Power sources**
Check that the operating voltage of your unit is identical with the voltage of your local power supply.
7. **Servicing**
Do not attempt to service this projector yourself. Refer all servicing to qualified service personnel.
8. **Replacement parts**
When replacement parts are required, be sure that the replacement parts are specified by the manufacture. Unauthorized substitutions may result in fire, electric shock or other hazards.
9. **Moisture Condensation**
Never operate this projector immediately after moving it from a cold location to a warm one. When the projector is exposed to such a change in temperature, moisture may condense on the lens and the crucial internal parts. To prevent the unit from possible damage, do not use the projector for at least 2 hours when there is an extreme or sudden change in temperature.

Notes on the AC power cord

AC Power Cord must meet the requirement of countries where you use this projector. Please confirm your AC plug type with the graphics below and ensure that the proper AC Power Cord is used. If the supplied AC Power Cord does not match your AC outlet, please contact your sales dealer. This projector is equipped with a grounding type AC line plug. Please ensure that your outlet fits the plug. Do not defeat the safety purpose of this grounding type plug. We highly recommend using a video source device also equipped with a grounding type AC line plug to prevent signal interference due to voltage fluctuations.

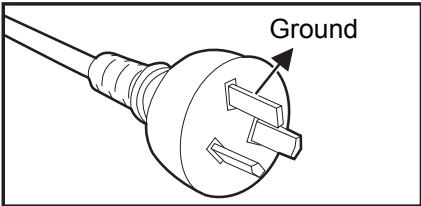

For Australia and Mainland China

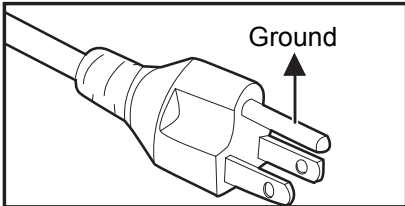

For the U.S.A. and Canada

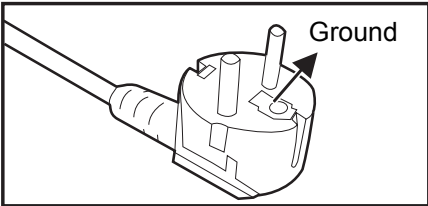

For Continental Europe

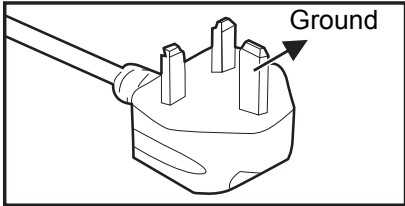

For the U.K.

Table of contents

Introduction	5
Projector features	5
Package contents	6
Product overview	7
Installation	11
Connecting to the Projector	11
Powering on/off the projector	13
Adjusting the projector height	14
Adjusting the projector focus	14
Adjusting projection image size	15
User Controls	17
Control panel & remote control	17
Securing the projector	23
Locking control keys	24
Setting the presentation timer	25
Using the projector in standby mode	26
Adjusting the sound	26
On-screen display menus	28
Menu tree	29
Using network features	44
Maintenance	50
Cleaning the projector housing	50
Specifications	51
Dimensions	52
Ceiling mount installation	52
Appendices	53
LED indicator messages	53
Compatibility Modes	54
Troubleshooting	58
RS-232 command and configuration	59

Introduction

Projector features

The projector integrates high-performance optical engine projection and a user - friendly design to deliver high reliability and ease of use.

The projector offers the following features:

- Laser-phosphor light source free from replacement
- Ultra-short throw (UST) projection lens delivers large images from a short projection distance
- HDMI x 2 inputs
- 2D keystone for easy horizontal and vertical keystone correction
- Corner Adj. allows you to adjust four corners of the projected image
- Power saving function decreasing the power consumption of the light by up to 30% when no input signal can be detected for a set period of time.
- Presentation timer for better control of time during presentations
- Blu-Ray 3D function supported
- Selectable quick power off function
- Color Management allowing color adjustments to your liking
- Screen Color correction allowing projection on surfaces of several predefined colors
- Quick auto search speeding up the signal detecting process
- HDMI CEC (Consumer Electronics Control) function allows synchronized power ON/OFF operation between the projector and a CEC-compatible DVD player device connected to the HDMI input of the projector

Note

- ***The information in this manual is subject to change without notices.***
- ***The reproduction, transfer or copy of all or any part of this document is not permitted without express written consent.***

Package contents

When you unpack the projector, make sure you have all these components:

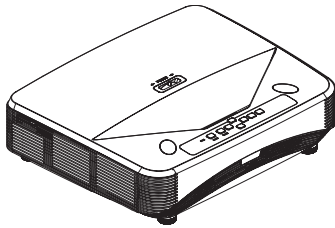

Projector

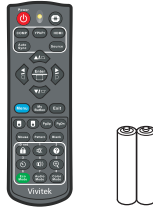

Remote control (IR) & batteries (AAA *2 PCS)

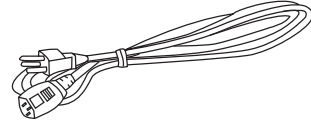

AC power cord

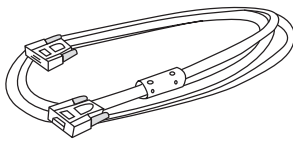

VGA cable (D-SUB to D-SUB)

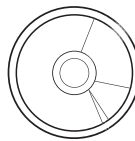

CD manual

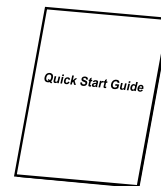

Quick start guide

Note

- **Contact your dealer immediately if any items are missing, appear damaged, or if the unit does not work.**
- **For maximum protection of the product, please save the original shipping carton and packing materials and repack your product as it was originally packed at the factory if you need to ship it.**

Product overview

Projector outlook

Front and top

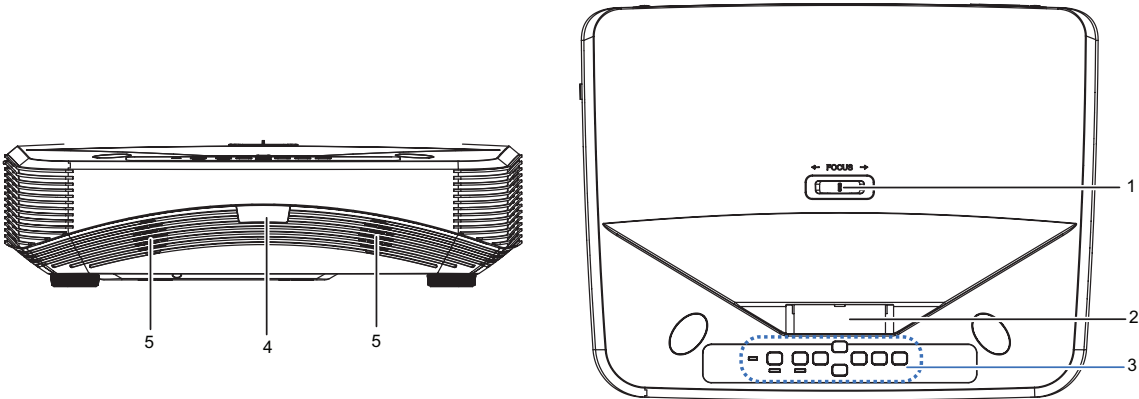

- 1. Focus switch
- 2. Lens
- 3. Control panel
- 4. IR remote control sensor
- 5. Speaker

Bottom and side

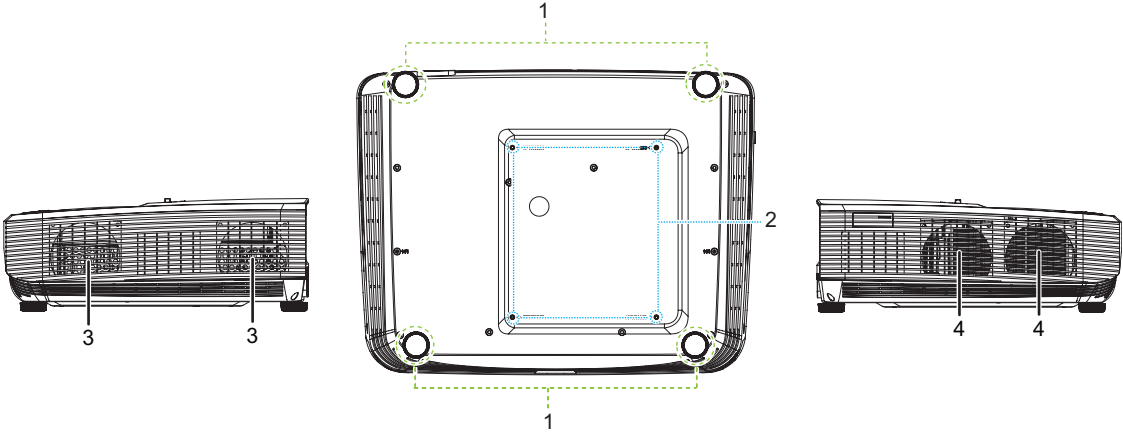

- 1. Adjuster feet
- 2. Ceiling mount holes
- 3. Ventilation holes (airflow out)
- 4. Ventilation holes (airflow in)

Rear

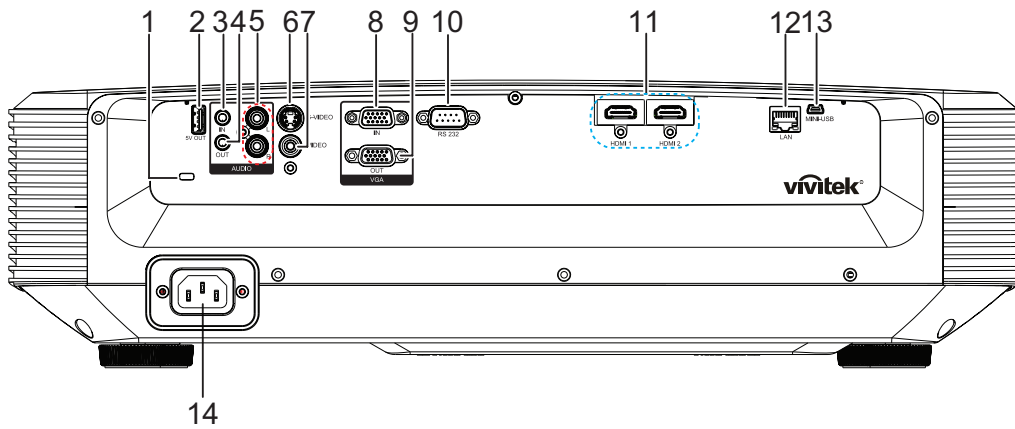



1. Kensington anti-theft lock slot
2. 5V output for power charging
3. Audio input jack
4. Audio output jack
5. Audio (L/R) input jack
6. S-Video input jack
7. Video input jack
8. RGB (PC)/Component video (YPbPr) signal input jack
9. RGB signal output jack
10. RS232 control port
11. HDMI 1/HDMI 2 input jack
12. RJ45 LAN input jack
13. Mini-USB jack for service
14. AC power cord inlet

Note

- ***This projector can be used with a ceiling mount for support. The ceiling mount is not included in the package.***
- ***Contact your dealer for information to mount the projector on a ceiling.***

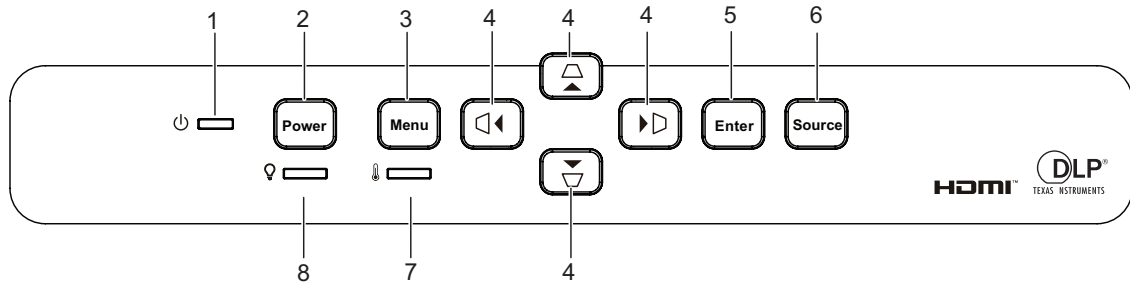
Control panel



1. Power LED indicator
2. Power button
3. Menu button
4.  Vertical and Horizontal Keystone buttons
4.  Four directional select buttons
5. Enter button
6. Source button
7. Temperature LED indicator
8. Light LED indicator

Remote control

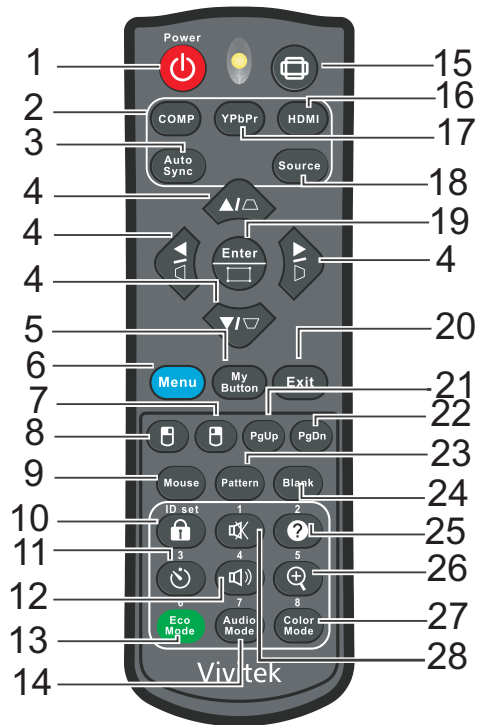

- | | |
|-----------------------|--|
| 1. Power | 2. Computer |
| 3. Auto Sync | 4. $\Delta/\nabla/\triangleleft/\triangleright$ Vertical and Horizontal Keystone buttons
$\blacktriangle/\blacktriangledown/\blacktriangleleft/\blacktriangleright$ Four directional select buttons |
| 5. My Button | 6. Menu |
| 7. Right mouse | 8. Left mouse |
| 9. Mouse | 10. Lock/ID Set |
| 11. Timer | 12. Volume |
| 13. Eco Mode | 14. Audio Mode |
| 15. Aspect | 16. HDMI |
| 17. YPbPr | 18. Source |
| 19. Enter/Corner Adj. | 20. Exit |
| 21. Page Up | 22. Page Down |
| 23. Pattern | 24. Blank |
| 25. Help | 26. Magnify |
| 27. Color Mode | 28. Mute |

Installation

Connecting to the Projector

Connecting a Computer/Notebook

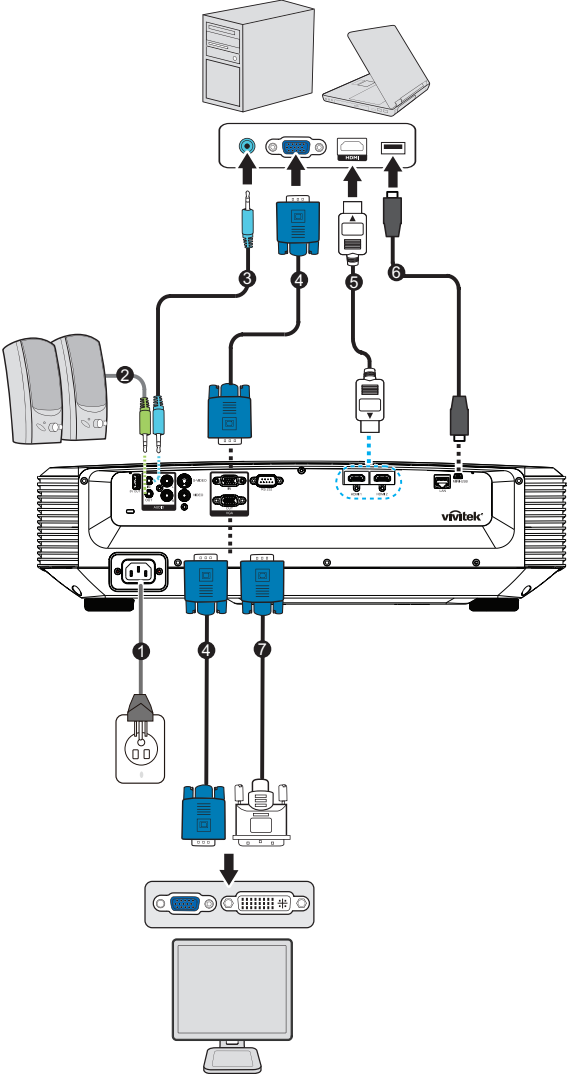

- 1. Power cord
- 2. Audio Out cable
- 3. Audio In cable
- 4. VGA cable (D-Sub to D-Sub)
- 5. HDMI cable
- 6. Mini-USB cable
- 7. VGA (D-Sub) to HDTV (RCA) cable

Connecting a Video source

DVD player, Blu-ray player, Set-top box, HDTV receiver

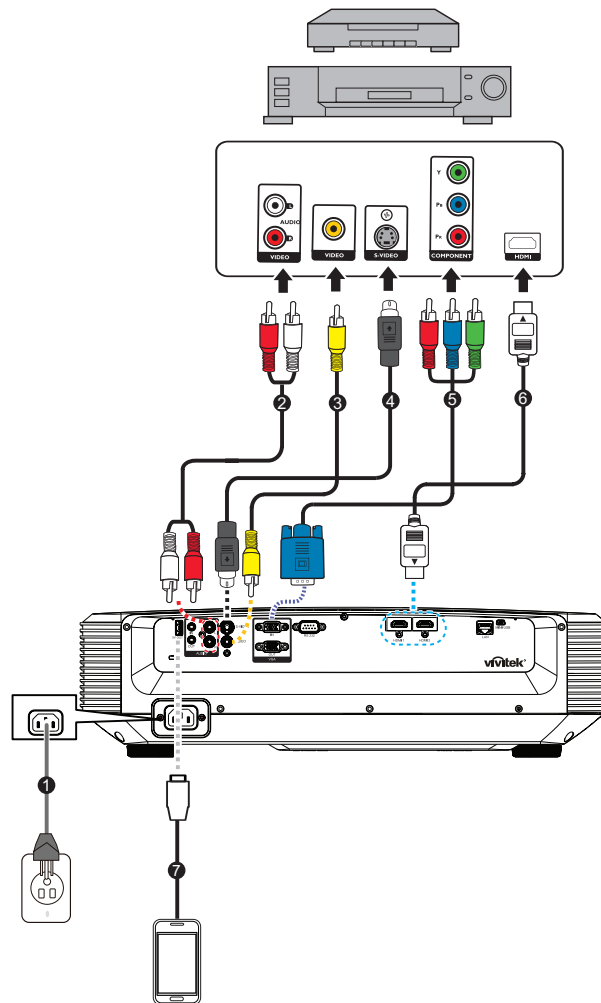

1. Power cord
2. Audio (L/R) cable
3. Composite Video cable
4. S-Video cable
5. 3 RCA to mini D-sub 15 pin cable
6. HDMI cable
7. USB cable for charging device

Powering on/off the projector

Powering on the projector:



1. Complete the AC power cord and peripheral signal cable(s) connections.
2. Press  to turn on the projector.
The projector takes a minute or so to warm up.
 - If the projector is still hot from previous activity, it will run the cooling fan for approximately 60 seconds before energizing the light.
3. Turn on your source (computer, notebook, DVD, etc.).
 - If you are connecting multiple sources to the projector simultaneously, press **Source** to select your desired signal or press your desired signal key on the remote control.
 - If the projector doesn't detect a valid signal, the message 'No Signal' will continue to be displayed.
 - Be sure the **Auto Source** function in the **Source** menu is **On** if you want the projector to automatically search for the signals.



Warning

- *Never look into the lens when the light is on. This can damage your eyes.*
- *This focal point concentrates high temperature. Do not place any object near it to avoid possible fire hazard.*

Powering off the projector:

1. Press  to turn off the projector light. You will see a message "Power off? Press Power again" appear on the screen.
2. Press  again to confirm.
 - The Power LED begins flashing and the projector will enter standby mode.
 - If you want to turn the projector back on, you must wait until the projector has completed the cooling cycle and has entered standby mode. Once in standby mode, simply press  to restart the projector.
3. Disconnect the AC power cord from the electrical outlet and the projector.
4. Do not turn on the projector right after power off.

Adjusting the projector height

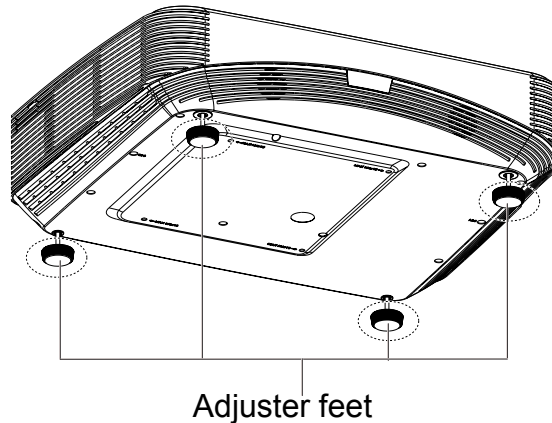

The projector is equipped with 4 adjuster feet to adjust the image height. To raise or lower the image, turn the adjuster feet to fine-tune the height.

Note

- *To avoid damaging the projector, make sure that the adjuster feet are fully retracted before placing the projector in its carrying case.*

Adjusting the projector focus

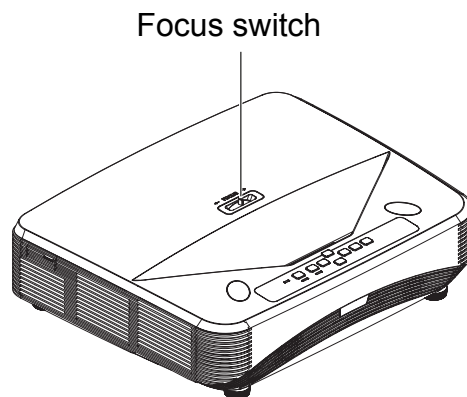

To focus the image, slide the focus switch until the image is clear.

- Standard throw series (1080p): The projector will focus at distances from 407.2 to 779.8 mm counted from the center of lens.
- Standard throw series (WXGA): The projector will focus at distance from 407.2 to 779.8 mm counted from the center of lens.
- Standard throw series (XGA): The projector will focus at distance from 407.2 to 779.8 mm counted from the center of lens.

Adjusting projection image size

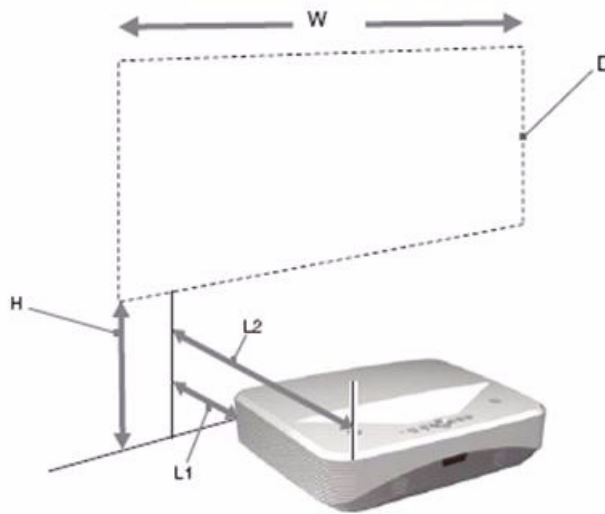

L1: Distance from a projection surface to the rear of the unit

L2: Distance from a projection surface to the front of the unit

D: Projection image size

H: Distance from a floor to the bottom of a projection image

1080p (16:9)

Projection image size			Installation distance	
Diagonal (D)	With x Height	Bottom height (H)	From a projecting surface to the rear of the unit L1	From a projecting surface to the front of the unit L2
inch	m x m	mm		
80	1.77 x 0.99	281.8	41.4	431.4
105	2.32 x 1.3	340.2	174.5	564.5
125	2.77 x 1.56	386.9	281.0	671.0
150	3.32 x 1.87	445.2	414.0	804.0

WXGA (16:10)

Projection image size			Installation distance	
Diagonal (D)	With x Height	Bottom height (H)	From a projecting surface to the rear of the unit L1	From a projecting surface to the front of the unit L2
inch	m x m	mm		
80	1.72 x 1.08	254.7	41.4	431.4
105	2.26 x 1.41	305.2	174.5	564.5
125	2.69 x 1.68	345.6	281.0	671.0
150	3.23 x 2.02	396.1	414.0	804.0

XGA (4:3)

Projection image size			Installation distance	
Diagonal (D)	With x Height	Bottom height (H)	From a projecting surface to the rear of the unit L1	From a projecting surface to the front of the unit L2
inch	m x m	mm		
80	1.63 x 1.22	306.7	76.2	466.2
105	2.13 x 1.6	373.2	214.3	604.3
125	2.54 x 1.91	427.5	324.8	714.8
150	3.05 x 2.29	494.0	463.0	853.0

- These tables are for user's reference only.

User Controls

Control panel & remote control

Control panel

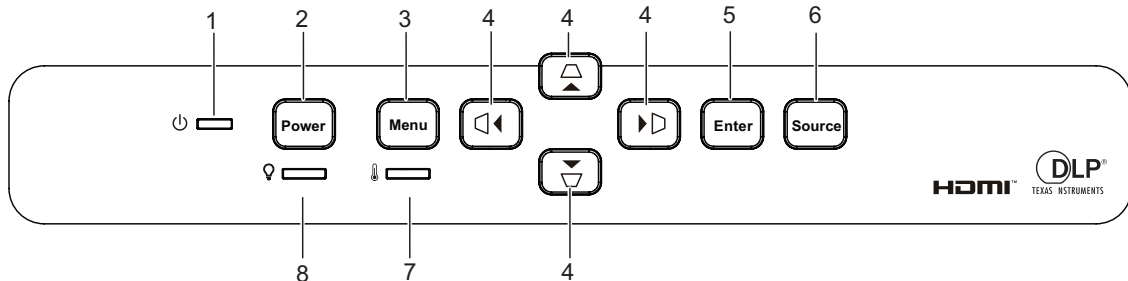





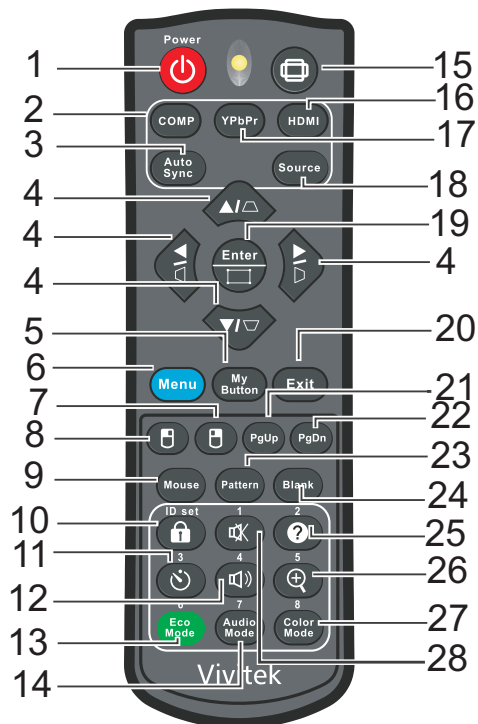



- 1. Power LED indicator**
Refer to “LED Indicator Messages”.
- 2. Power**
Turn the projector on or off.
- 3. Menu**
Display or exit the on-screen display menus.
- 4. Vertical and Horizontal Keystone buttons**
Manually corrects distorted images resulting from an angled projection.
 Four directional select buttons
Selects the desired menu items and makes adjustments.
- 5. Enter**
Enacts the selected On-Screen Display (OSD) menu item.
- 6. Source**
Display the source selection bar.
- 7. Temperature LED indicator**
Refer to “LED Indicator Messages”.
- 8. Light LED indicator**
Refer to “LED Indicator Messages”.

Remote control





1. **Power**
Turn the projector on or off.
2. **Computer**
Display Computer signal.
3. **Auto Sync**
Automatically determines the best picture timings for the displayed image.
4. **Keystone buttons**
Manually corrects distorted images resulting from an angled projection.
Four directional select buttons
Selects the desired menu items and makes adjustments.
5. **My Button**
User definable key for customized function.
6. **Menu**
Display on-screen display menus.
7. **(Right mouse)**
Perform the right button of the mouse when mouse mode is activated.
8. **(Left mouse)**
Perform the left button of the mouse when mouse mode is activated.
9. **Mouse**
Switch between the normal and mouse modes.

- 10.  (Lock/ID Set)**
Lock: Activates or disables panel key lock.
ID Set: No function.
- 11.  (Timer)**
Activate P-Timer OSD menu.
- 12.  (Volume)**
Display Volume adjustable menu.
- 13. Eco Mode**
Switch the light mode between Normal and Eco.
- 14. Audio Mode**
Switch the audio mode from Video, Speech to Entertainment.
- 15.  (Aspect)**
Select the display aspect ratio.
- 16. HDMI**
Switch HDMI signal between HDMI1 and HDMI2.
- 17. YPbPr**
No function
- 18. Source**
Display the source selection bar.
- 19. Enter/  (Corner Adj.)**
Enacts the selected On-Screen Display (OSD) menu item.
Displays the Corner Adj. page.
- 20. Exit**
Goes back to previous OSD menu, exits and saves menu settings.
- 21. PgUp (Page Up)**
Perform page up function when mouse mode is activated.
- 22. PgDn (Page Down)**
Perform page down function when mouse mode is activated.
- 23. Pattern**
Display embedded test pattern.
- 24. Blank**
Hide the screen picture.
- 25.  (Help)**
Display Help menu.
- 26.  (Magnify)**
Displays the zoom bar that magnifies or reduces the projected picture size.
- 27. Color Mode**
Select the picture setup mode.
- 28.  (Mute)**
Toggles the projector audio between on and off.

Using the remote mouse control

The capability of operating your computer with the remote control gives you more flexibility when delivering presentations.

1. Connect the projector to your PC or notebook with a USB cable prior to using the remote control in place of your computer's mouse. See ["Installation" on page 11](#) for details.
2. Set the input signal to VGA IN.
3. Press Mouse on the remote control to switch from the normal mode to the mouse mode. An icon appears on the screen to indicate the activation of the mouse mode.
4. Perform the desired mouse controls on your remote control.
 - To move the cursor on the screen, press ▲/ ▼/ ◀/ ▶.
 - To left-click, press .
 - To right-click, press .
 - To operate your display software program (on a connected PC) which responds to page up/down commands (like Microsoft PowerPoint), press Page Up/Page Down.
 - To return to the normal mode, press **Mouse** again or other keys except for the mouse related multi-function keys.

Installing the batteries

1. Open the battery cover in the direction shown.

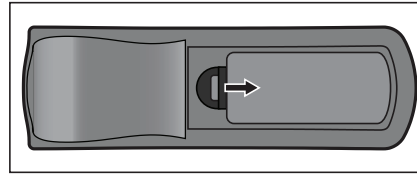

2. Install batteries as indicated by the diagram inside the compartment.

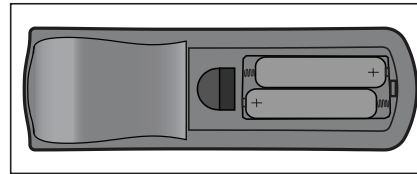

3. Close the battery cover into position.

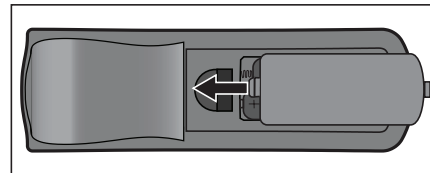

Caution

- **Risk of explosion if battery is replaced by an incorrect type.**
- **Dispose of used batteries according to the instructions.**
- **Make sure the plus and minus terminals are correctly aligned when loading a battery.**



Note

- **Keep the battery out of the reach of children.**
- **Remove batteries from remote control when not using for extended periods.**
- **Do not recharge the battery or expose the battery to fire or water.**
- **Do not dispose the used battery along with household waste. Dispose used batteries according to local regulations.**
- **Danger of explosion may happen if batteries are incorrectly replaced. Replace only with the same type recommended by the manufacturer.**
- **Battery should not be in or near to fire or water, keep batteries in a dark, cool and dry place.**
- **If suspect battery leakage, wipe out the leakage and then replace a new battery. If the leakage adheres to your body or clothes, rinse well with water immediately.**

Remote control operation

Point the remote control at the infrared remote sensor and press a button.

- Operating the projector from the front.

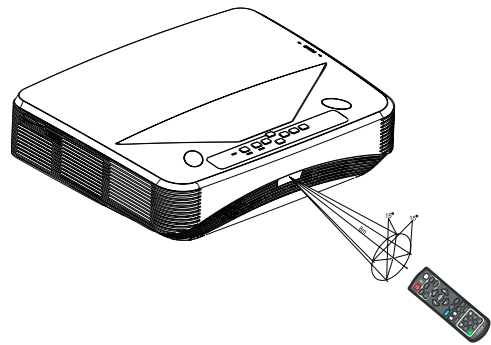

Note

- *The remote control may not operate when there is sunlight or other strong light such as a fluorescent light shining on the remote sensor.*
- *Operate the remote control from a position where the remote sensor is visible.*
- *Do not drop the remote control or jolt it.*
- *Keep the remote control out of locations with excessively high temperature or humidity.*
- *Do not get water on the remote control or place wet objects on it.*
- *Do not disassemble the remote control.*

Securing the projector

Setting a password

1. Open the OSD menu and go to the **Settings 2 > Advanced > Security Settings** menu. Press **Enter**. The **Security Settings** page displays.
2. Highlight **Change Password** and press **Enter**.
3. According to the password you desire to set, press the arrow keys to enter six digits for the password.
4. Confirm the new password by re-entering the new password.
5. Go back to **Settings 2 > Advanced > Security Settings > Power On Lock** menu, and press **Enter**. You will be asked to input password. Once the password is set, the OSD menu returns to the **Power On Lock**. Select **On** by pressing **◀/▶**.
6. To leave the OSD menu, press **Menu/Exit**.

Entering the password recall procedure

If the password function is activated, you will be asked to enter the six-digit password every time you turn on the projector.

1. If you enter an incorrect password 5 times in succession, the projector will display a coded number on the screen when you press the auto key 3~5 seconds.
2. Write down the number and turn off your projector.
3. Seek help from the local service center to decode the number. You may be required to provide proof of purchase documentation to verify that you are an authorized user of the projector.

Changing the password

1. Open the OSD menu and go to the **Settings 2 > Advanced > Security Settings > Change Password** menu and press **Enter**.
2. Enter the old password.
 - If the password is correct, another message **"INPUT NEW PASSWORD"** displays.
 - If the password is incorrect, the password error message displays, and the message **"INPUT CURRENT PASSWORD"** displays for your retry. You can press **Menu/Exit** to cancel the change or try another password.
3. Enter a new password.
4. Confirm the new password by re-entering the new password.
5. You have successfully assigned a new password to the projector. Remember to enter the new password next time the projector is started.
6. To leave the OSD menu, press **Menu/Exit**.

Setting the presentation timer

The presentation timer can indicate the presentation time on the screen to help you achieve better time management when giving presentations. Follow these steps to utilize this function:

1. Press **Timer** on the remote control to access the Presentation Timer menu or go to the **Settings 1 > Advanced > Presentation Timer** menu and press **Enter** to display the Presentation Timer page.
2. Highlight **Timer Period** and decide the timer period by pressing **◀/▶**.
3. Press **▼** to highlight **Timer Display** and choose if you want the timer to show up on the screen by pressing **◀/▶**.



Selection	Description
Always	Displays the timer on screen throughout the presentation time.
1 min/2 min/3 min	Displays the timer on screen in the last 1/2/3 minute(s).
Never	Hides the timer throughout the presentation time.

4. Press **▼** to highlight **Timer Position** and set the timer position by pressing **◀/▶**.
Top-Left → Bottom-Left → Top-Right → Bottom-Right
5. Press **▼** to highlight **Timer Counting Direction** and select your desired counting direction by pressing **◀/▶**.

Selection	Description
Count Up	Increases from 0 to the preset time.
Count Down	Decrease from the preset time to 0.

6. Press **▼** to highlight **Sound Reminder** and select your desired counting direction by pressing **◀/▶**. If you select **On**, a double beep sound will be heard at the last 30 seconds of counting down/up, and a triple beep sound will be produced when the timer is up.
7. To activate the presentation timer, press **▼** to highlight **Start Counting** and select **Yes**.
8. To cancel the timer, highlight **Start Counting** and select **No**.

Using the projector in standby mode

Some of the projector functions are available in standby mode (plugged in but not turned on). To use these functions, be sure you have turned on the corresponding menus under **Source > Standby Settings**, and the cable connections are correctly made. For the connection methods, see the "[Installation](#)" on page 11 chapter.

Active VGA out

Selecting **On** outputs a VGA signal when the **VGA IN** and **VGA OUT** sockets are correctly connected to devices. The projector outputs the signal received only from **VGA IN**.

Active Audio out

Selecting **On** outputs an audio signal when the **AUDIO IN** socket is correctly connected to a proper device.

LAN Control

Selecting **On** allows the projector to provide the network function when it is in standby mode. See "[Using network features](#)" on page 44 for details.

Adjusting the sound

The sound adjustments made as below will have an effect on the projector speaker. Be sure you have made a correct connection to the projector audio input/output jacks. See "[Installation](#)" on page 11 for more details.

Adjusting the audio mode

1. Open the OSD menu and go to the **Settings 2 > Audio Settings > Audio Mode** menu.
2. Press **◀ / ▶** to select a preferred audio mode.
 - *If available, you can press **Audio Mode** on the remote control to select a preferred audio mode.*

Muting the sound

1. Open the OSD menu and go to the **Settings 2 > Audio Settings > Mute** menu.
2. Press **◀ / ▶** to select **On**.
 - *If available, you can press **⏏** on the remote control to toggle the projector audio between on and off.*

Adjusting the sound level

1. Open the OSD menu and go to the **Settings 2 > Audio Settings > Audio Volume** menu.
2. Press **◀ / ▶** to select a desired sound level.
 - *If available, you can press **🔊** on the remote control to adjust the projector's sound level.*

Turning off the Power On/Off Ring Tone

1. Open the OSD menu and go to the **Settings 2 > Audio Settings > Power On/Off Ring Tone** menu.
2. Press ◀ / ▶ to select **Off**.
 - *The only way to change Power On/Off Ring Tone is setting On or Off here. Setting the sound mute or changing the sound level will not affect the Power On/Off Ring Tone.*

On-screen display menus

The projector has multilingual on-screen display menus that allow you to make image adjustments and change a variety of settings.

How to operate

1. Press **Menu** to open the OSD menu.
2. When OSD is displayed, use ◀/▶ to select any feature in the main menu.
3. After selecting the desired main menu item, press ▼ to enter sub-menu for feature setting.
4. Use ▲/▼ to select the desired item and adjust the settings with ◀/▶.
5. Press **Menu**, the screen will return to the main menu or go back to the upper level of the menu.
6. Press **Menu** or **Exit** to leave and save the settings.

Menu tree

Main Menu	Sub Menu	Settings				
Display	Screen Color	Off / Blackboard / Greenboard / Whiteboard				
	Aspect Ratio	Auto / 4:3 / 16:9 / Panorama / Anamorphic / 2.35:1 / 16:10 / 16:6				
	Keystone	H: -30 - 30 V: -30 - 30				
	Corner Adj.	Top-Right / Top-Left / Bottom-Left / Bottom-Right				
	Position					
	Phase	0 - 31				
	H. Size	-15 - 15				
	Digital Zoom					
Image	Color Mode	Bright / Presentation / Movie				
	Brightness	0 - 100				
	Contrast	-50 - 50				
	Color Temperature Fine Tuning	Warm / Normal / Cold				
		R Gain				
		G Gain				
		B Gain				
		R Offset				
		G Offset				
	B Offset					
	OverScan	Off / 1 / 2 / 3 / 4 / 5				
	HDMI Settings	HDMI Format	HDMI Timing	Auto / RGB / YUV		
		HDMI Range	Auto / Enhanced / Normal			
	Advanced	Tint	-50 - 50			
		Color	-50 - 50			
		Sharpness	0 - 31			
		Gamma	1 / 2 / 3 / 4 / 5			
		Brilliant Color	Off / 1 / 2 / 3 / 4 / 5 / 6 / 7 / 8 / 9 / 10			
		Noise Reduction	0 - 31			
		Color Manager	Primary color	R / G / B / C / M / Y		
			Hue	-99 - 99		
Saturation			0 - 199			
Gain			5 - 195			
Reset Color Settings	Reset / Cancel					

Source	Auto Source		Off / On
	3D Settings	3D Format	Auto
			Off
			Top-Bottom
			Frame Sequential
			Frame Packing
			Side By Side
		3D Sync Invert	Off / On
	Standby Settings	Active VGA out	Off / On
		Active Audio out	Off / On
		LAN Control	Off / On
	Auto Power On	Computer	Off / On
		CEC	Off / On
		Direct Power On	Off / On
	Power Saving	Auto Power Off	Disable / 10 / 20 / 30 min
		Sleep Timer	Disable / 30 Min / 1 hr / 2 hr / 3 hr / 4 hr / 8 hr / 12 hr
		Energy Saving	Off / On
	Smart Restart		Off / On
	Quick Power Off		Off / On
	Network	DHCP	DHCP on / Static IP
		IP Address	
Subnet Mask			
Default Gateway			
DNS Server			
Apply			

Settings 1	Language	English / Deutsch / Français / Español / Italiano / Русский / 한국어 / ไทย / Português / 简体中文 / 繁體中文 / 日本語 / Nederlands / Svenska / Türkçe / Čeština / Suomi / Polski / Indonesia / العربية / हिन्दी		
	Projection		Front Table / Rear Table / Rear Ceiling / Front Ceiling	
	Menu Settings	Menu Display Time	5 sec / 10 sec / 15 sec / 20 sec / 25 sec / 30 sec	
		Menu Position	Center / Top-Left / Top-Right / Bottom-Left / Bottom-Right	
	Blank Timer		Disable / 5 Min / 10 Min / 15 Min / 20 Min / 25 Min / 30 Min	
	Splash Screen		Factory Default / Black / Blue / Off	
	My Button	Auto / Projection / Menu Position / Color Tempera- ture Fine Tuning / Brightness / Contrast / 3D Set- tings / Screen Color / Splash Screen / Message / Auto Source / CEC / Light Mode / Power Saving / Freeze / Information / Closed Caption / Audio Mode		
	Advanced	Pattern	Off / 1	
		Message	On / Off	
		Presentation Timer	Timer Period	1~ 240 min
Timer Display			Always / 3 min / 2 min / 1 min / Never	
Timer Position			Top-Left / Bottom-Left / Top-Right / Bottom-Right	
Timer Count- ing Direction			Count Down / Count Up	
Sound Reminder			On / Off	
Start Counting	Yes / No			

Settings 2	High Altitude Mode		Off / On	
	Audio Settings	Audio Mode	Video / Speech / Entertainment	
		Mute	Off / On	
		Audio Volume	0 - 20	
		Power On/Off Ring Tone	On / Off	
	Closed Caption	Closed Caption Enable	Off / On	
		Caption Version	CC1 / CC2 / CC3 / CC4	
	Light Settings	Light Mode	Normal / Eco	
		Reset Light Hours	Reset / Cancel	
		Light Hours		
	Advanced	Security Settings	Change Password	
			Power On Lock	Off / On
	Panel Key Lock	Off / On		
Reset Settings		Reset / Cancel		
Information	Current System Status		Source	
			Color Mode	
			Resolution	
			Color System	
			Light Hours	
			IP Address	
			MAC Address	
			Firmware Version	

Display

Screen Color

The Screen Color feature can help correct the projected picture's colors to prevent possible color difference between the source and projected pictures.

There are several precalibrated colors to choose from: Whiteboard, Greenboard, and Blackboard.

Aspect Ratio

Select how the picture fits on the screen:

- Auto:
Scales an image proportionally to fit the projector's native resolution in its horizontal or vertical width. You want to make most use of the screen without altering the source image's aspect ratio.
- 4:3:
Scales an image so that it is displayed in the center of the screen with a 4:3 aspect ratio, as it displays them without aspect alteration.
- 16:9:
Scales an image so that it is displayed in the center of the screen with a 16:9 aspect ratio, as it displays them without aspect alteration.
- Panorama
Scales a 4:3 image vertically and horizontally in a non-linear manner so that it fills the screen.
- Anamorphic:
Scales a 2.35:1 aspect image so that it fills the screen.
- 2.35: 1
Scales an image so that it is displayed in the center of the screen with a 2.35:1 aspect ratio without aspect alteration.
- 16:10:
Scales an image so that it is displayed in the center of the screen with a 16:10 aspect ratio, as it displays them without aspect alteration.
- 16:6:
Scales an image so that it is displayed in the center of the screen with a 16:6 aspect ratio, as it displays them without aspect alteration.

Keystone

Manually correct distorted images resulting from an angled projection.

Press Keystone $\triangle/\nabla/\square/\triangleright$ on the projector or remote control to display the Keystone correction page.

Press \triangle to correct keystone at the top of the image.

Press ∇ to correct keystone at the bottom of the image.

Press \square to correct keystone at the left of the image.

Press \triangleright to correct keystone at the right of the image.

Corner Adj.

Manually adjust four corners of the image by setting the horizontal and vertical values.

1. Press ▲/▼/◀/▶ to select one of the four corners and press **Enter**.
2. Press ▲/▼ to adjust vertical values.
3. Press ◀/▶ to adjust horizontal values.

Position

Displays the position adjacent page. This function is only available when a PC type input signal is selected.

Phase

Adjusts the clock phase to reduce image distortion. This function is only available when a PC type input signal is selected.

H. Size

Adjusts the horizontal width of the image. This function is only available when a PC type input signal is selected.

Digital Zoom

Using the remote control

1. Press ⊕ on the remote control to display the Zoom bar.
2. Press ▲/▶ to magnify the picture to a desired size.
3. Press ▲ repeatedly to magnify the picture to a desired size.
4. To navigate the picture, press **Enter** to switch to the panning mode and press the directional arrows (▲, ▼, ◀, ▶) to navigate the picture.
5. To reduce size of the picture, press **Enter** to switch back to the zoom in/out functionality, and press **Auto Sync** to restore the picture to its original size. You can also press ▼ repeatedly until it is restored to the original size.

Using the OSD menu

1. Press **Menu** and then select **Display** menu.
2. Press ▼ to select **Digital Zoom** and press **Enter**. The Zoom bar displays.
3. Repeat steps 3-5 in the section of Using the remote control above.

Image

Color Mode

There are many factory presets optimized for various types of images.

- Bright: Maximizes the brightness of the projected image. This mode is suitable for environments where extra-high brightness is required.
- Presentation: Is designed for presentations under daylight environment to match PC and notebook coloring.
- Movie: Switches between high brightness performance and accurate color performance.

Brightness

Brighten or darken the image.

Contrast

Sets the difference between light and dark areas.

Color Temperature Fine Tuning

Sets a color temperature from Warm, Normal, Neutral and Cool.

- Warm: Makes images appear reddish white.
- Normal: Maintains normal colorings for white.
- Cold: With the highest color temperature, Cool makes the image appear the most bluish white than other settings.
- R Gain/G Gain/B Gain: Adjusts the contrast levels of Red, Green, and Blue.
- R Offset/G Offset/B Offset: Adjusts the brightness levels of Red, Green, and Blue.

OverScan

OverScan function removes the noise in a video image. Overscan the image to remove video encoding noise on the edge of video source.

HDMI Settings

HDMI Format

Selects appropriate HDMI timing.

Note

- *This function is only available when the HDMI-input port is in use.*

HDMI Range

- Enhanced : The range for HDMI output signal is from 0 - 255.
- Normal: The range for HDMI output signal is from 16 - 235.

Advanced

Tint

Adjusts the red and green color tones of the image.

Color

The higher the value, the more reddish the picture becomes. The lower the value, the more greenish the picture becomes.

Sharpness

Adjusts the image to make it look sharper or softer.

Gamma

Effect the represent of dark scenery. With greater gamma value, dark scenery will look brighter.

Brilliant Color

This adjustable item utilizes a new color-processing algorithm and system level enhancements to enable higher brightness while providing true, more vibrant colors in picture. The range is from "1" to "10". If you prefer a stronger enhanced image, adjust toward the maximum setting. For a smoother, more natural image, adjust toward the minimum setting.

Noise Reduction

This function reduces electrical image noise caused by different media players. The higher the setting, the less the noise.

Color Manager

The Color Manager provides six sets (RGBCMY) of colors to be adjusted. When you select each color, you can independently adjust its hue, saturation and gain according to your preference.

Reset Color Settings

Reset the Color Mode settings of the current input source to default values.

Source

Auto Source

Automatically scan through all the input source if the function in the OSD menu is On. The function will stop the signal auto scan process and fix the signal source you preferred if you turn Off the Auto Source.

3D Settings

This projector features a 3D function which enables you to enjoy the 3D movies, videos, and sporting events in a more realistic way by presenting the depth of the images. You need to wear a pair of 3D glasses to view the 3D images.

3D Format

If the projector cannot recognize the 3D format, press ▲/▼ to choose a 3D Format.

3D Sync Invert

When you discover the inversion of the image depth, enable this function to correct the problem.

Standby Settings

Active VGA out

Set whether the VGA out function works when the projector is in standby (powered off but connected to AC power). When selecting **On**, **VGA OUT** will be output. When selecting **Off**, power consumption is under 0.5W.

Active Audio out

Set whether the audio out function works when the projector is in standby (powered off but connected to AC power). When selecting **On**, **AUDIO IN** will be output. **AUDIO OUT** port is also active. When selecting **Off**, power consumption is under 0.5W. When selecting **Off**, both **AUDIO IN** and **AUDIO OUT** are **Off**.

LAN Control

Set whether the network function works when the projector is in standby (powered off but connected to AC power).

Note

- *Less than 0.5W power consumption when LAN Control is turned Off.*
- *When Power Saving is On, the Active VGA out and Active Audio out settings are not available.*

Auto Power On

Computer

Selecting **On** the projector will turn on automatically when Computer signal is detected.

CEC

This projector supports CEC (Consumer Electronics Control) function for synchronized power on/off operation via HDMI connection. That is, if a device that also supports CEC function is connected to the HDMI input of the projector, when the projector's power is turned off, the power of the connected device will also be turned off automatically. When the power of the connected device is turned on, the projector's power will be turned on automatically.

Note

- *When connected to the HDMI input of the projector via an HDMI cable, and its CEC function is turned on.*
- *Depending on the connected device, the CEC function may not work.*
- *The function can't be enabled when Active VGA out/Active Audio out function is disabled.*
- *The projector doesn't support CEC function when it is in standby mode with power consumption of 0.5W.*

Direct Power On

Selecting **On** the projector will turn on automatically after the power cord has been connected and power has been applied.

Power Saving

Auto Power Off

The projector lowers the projector power if no input source is detected after 5 minutes to prevent unnecessary waste of light life. You can further decide if you would like the projector to turn off automatically after a set period of time.

When **Disable** is selected, the projector power will be reduced to 30% after no signal is detected for 5 minutes.

If you select **10 Min**, **20 Min** or **30 Min**, the projector power will be reduced to 30% after no signal is detected for 5 minutes. And when **10 Min**, **20 Min** or **30 Min** is up, the projector will turn off automatically.

Sleep Timer

This function allows the projector to turn off automatically after a set period of time to prevent unnecessary waste of light life.

Energy Saving

Selecting **On** activates this function.

Smart Restart

It takes some time to initiate this function. Make sure the projector has been turned on for more than 4 minutes. If the projector is resumed by using the Smart Restart feature, this function can be executed immediately.

Quick Power Off

- **On:** Quick power on function speeds up the cooling process when turning off the projector.
- **Off:** Turn off with cooling procedure.

Note

- *When Off is selected, the Smart Restart function will be automatically turned Off.*

Network

Allow you to configure the wired LAN settings. Refer to page [44](#).

- DHCP:
 - When selecting "DHCP on", "IP Address", "Subnet Mask", "Default Gateway" and "DNS Server" will be gray out.
 - When selecting "Static IP", "IP Address", "Subnet Mask", "Default Gateway" and "DNS Server" will be available.
- IP Address: Numerical address to identify networked computers.
 - The IP Address is the number that identifies this projector on the network. You cannot have two devices with the same IP Address on the same network.
 - The IP Address "0.0.0.0" is prohibited.
- Subnet Mask: A numeric value to define the number of bits used for a network address of a divided network (or subnet) in an IP Address.
 - The Subnet Mask "0.0.0.0" is prohibited.
- Default Gateway: A server (or router) to communicate across networks (subnets) that are divided by Subnet Mask.
- DNS Server: Setup DNS server address when DHCP is disable.
- Apply: Save and execute the wired LAN settings.

Settings 1

Language

Select the language used by the on-screen menu.

Projection

Adjust the picture to match the orientation of the projector: upright or upside-down, in front of or behind the screen. Invert or reverse the image accordingly.

Menu Settings

Menu Display Time

Duration of OSD menu display countly starts (at idle state by second).

Menu Position

Choose the menu location on the display screen.

Blank Timer

Sets the image blank time when the Blank Timer feature is activated, once elapsed the image will return to the screen.

Splash Screen

Allows you to select which logo screen will display during projector start-up.

My Button

Allow user to define a short cut key on the remote control, and the function item is selected in OSD menu. Available options are: Auto, Projection, Menu Position, Color Temperature Fine Tuning, Brightness, Contrast, 3D Settings, Screen Color, Splash Screen, Message, Auto Source, CEC, Light Mode, Power Saving, Freeze, Information, Closed Caption, Audio Mode.

Advanced

Pattern

Display embedded test pattern.

Message

Enable or disable the message box at the right bottom of the screen.

Presentation Timer

Remind the presenter to finish the presentation within a certain time frame. See "[Setting the presentation timer](#)" on page 25.

Settings 2

High Altitude Mode

Use this function to allow the fans operate at full speed continuously to achieve proper high altitude cooling of the projector. If the projector is installed a filter cover, make sure that High Altitude Mode is set to On.

Audio Settings

See ["Adjusting the sound" on page 26](#) for details.

Audio Mode

Press ◀/▶ to select a preferred audio mode.

Mute

Cuts off the sound temporarily.

Audio Volume

Adjusts the projector's volume level.

Power On/Off Ring Tone

Setting the sound mute or changing the sound level will not affect the Power On/Off Ring Tone. The only way to change Power On/Off Ring Tone is setting On or Off here.

Closed Caption

Enable or disable closed captions and select CC1 (closed caption1, the most common channel), CC2, CC3 or CC4 for caption version.

Light Settings

Light Mode

Sets the Light Mode.

- Normal: 100% light power
- Eco: 80% light power

Reset Light Hours

Reset the Light Hour to 0 hours.

Light Hours

Display the light's elapsed operating time (in hours).

Advanced

Security Settings

- Change Password: Allows you to set or change the password.
- Power On Lock: If you enable this function, you will have to enter the password next time you turn on the projector.

See ["Securing the projector" on page 23](#) for details.

Panel Key Lock

Disables or enables all panel key functions except Power on the projector. See ["Locking control keys" on page 24](#) for details.

Reset Settings

Restore settings to factory default. The following settings will still remain: Keystone, Language, Projection, High Altitude Mode, Security Settings.

Information

Current System Status

Shows the current system status.

Source

Shows the current signal source.

Color Mode

Shows the selected mode in the Color Mode menu.

Resolution

Shows the native resolution of the input signal.

Color System

Shows input system format: RGB or YUV.

Light Hours

Displays the number of hours the light has been used.

IP Address

Display the IP address.

MAC Address

Display the MAC address.

Firmware Version

Shows firmware version.

Using network features

You can manage and control the projector from one or more remote computers when they are properly connected to the same local area network.

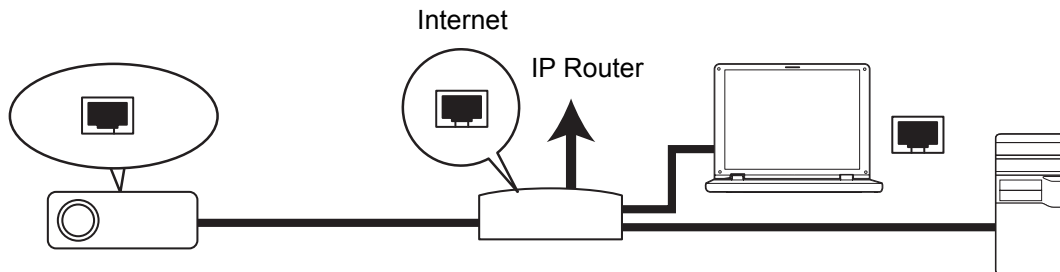

If you are in a DHCP on environment:

1. Take a RJ45 cable and connect one end to the RJ45 LAN input jack of the projector and the other end to the RJ45 port on your Ethernet or router.
2. Press **Menu** and then go to **Source > Network** menu.
3. Make sure the **DHCP** is **DHCP on**.
4. Press **▼** to highlight **Apply** and press **Enter**.
5. Please wait for around 15 - 20 seconds, and then re-enter the Wired LAN page. The **IP Address**, **Subnet Mask**, **Default Gateway** and **DNS Server** settings will be displayed. Note down the IP address displayed in the **IP Address** row.

Important

- *If the IP Address still does not appear, contact your network administrator.*
- *If the RJ45 cables are not properly connected, the IP Address, Subnet Mask, Default Gateway and DNS Server settings will display 0.0.0.0. Make sure the cables are properly connected and perform the procedures above again.*
- *If you wish to connect to the projector in its standby mode, be sure you have selected RJ45 and obtained the IP Address, Subnet Mask, Default Gateway and DNS Server information when the projector is on.*

If you are in a Static IP environment:

1. Repeat steps 1-2 above.
2. Make sure the **DHCP** is **Static IP**.
3. Contact your ITS administrator for information on the **IP Address**, **Subnet Mask**, **Default Gateway**, and **DNS Server** settings.
4. Press **▼** to select the item you want to modify and press **Enter**.
5. Press **◀/▶** to move the cursor and then enter the value.
6. To save the settings, press **Enter**. If you do not want to save the settings, press **Exit**.
7. Press **▼** to highlight **Apply** and press **Enter**.

Important

- **If the RJ45 cables are not properly connected, the IP Address, Subnet Mask, Default Gateway and DNS Server settings will display 0.0.0.0. Make sure the cables are properly connected and perform the procedures above again.**
- **If you wish to connect to the projector in its standby mode, be sure you have selected RJ45 and obtained the IP Address, Subnet Mask, Default Gateway and DNS Server information when the projector is on.**

Using network control

Once you have the correct IP address for the projector and the projector is on or in standby mode, you can use any computer that is on the same local area network to control the projector.

- **If you are using Microsoft Internet Explorer, make sure it is version 7.0 or higher.**
- **The screen shots in this manual are for reference only, and may differ from the actual design.**

1. Enter the address of the projector in the address bar of your browser and press **Enter**.

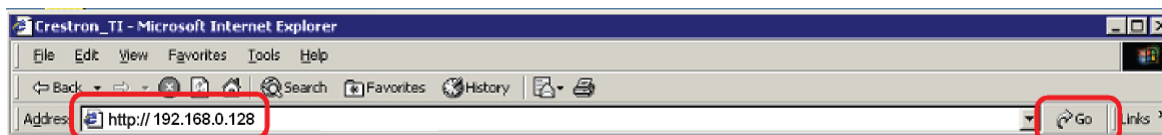

2. The main page of the Network Control appears.

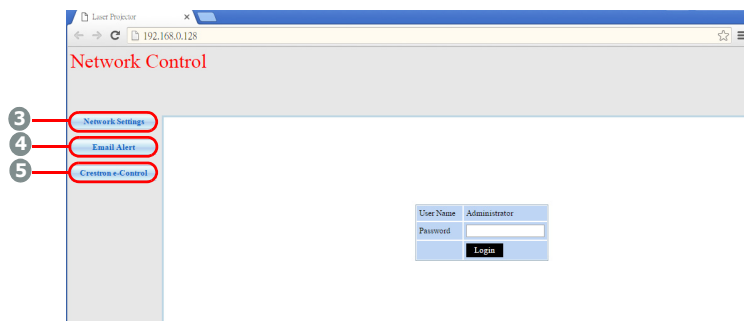

- **Accessing to Network Settings or Email Alert page requires Administrator password. The default password is "0000".**

3. This page allows you to make adjustments to the AMX and SNMP settings. In the AMX device discover row, when ON is selected, the projector can be detected by controllers of AMX connected to the same network. For the Details of AMX Device Discovery, visit the AMX web site at <http://www.amx.com/>.

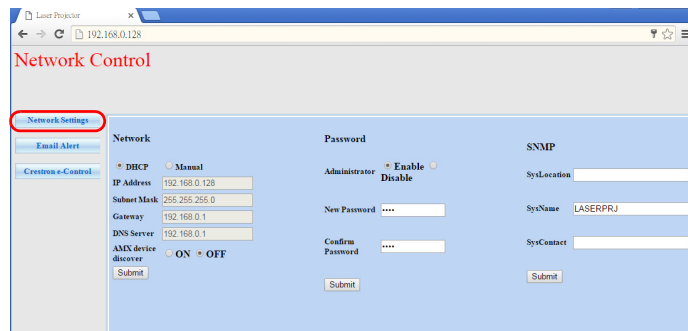

4. If your projector is connected to a network which supports Simple Mail Transfer Protocol (SMTP), you can configure it to alert you via email on significant events.

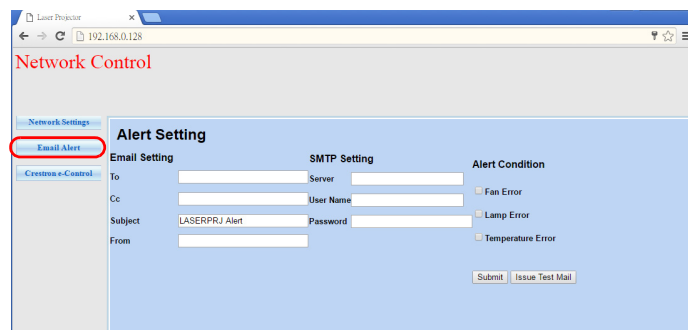

5. The Crestron (e-Control) page displays the Crestron e-Control user interface. See "[About Crestron e-Control®](#)" on page 47 for details.

Please pay attention to the limitation of input length (including space and other punctuation keys) in the list blow:

Category Item		Input-Length	Maximum Number of Characters
Network Settings	Network	DHCP/Manual	(N/A)
		IP Address	XXX.XXX.XXX.XXX
		Subnet Mask	XXX.XXX.XXX.XXX
		Gateway	XXX.XXX.XXX.XXX
		DNS Server	XXX.XXX.XXX.XXX
		AMX device discovery	(N/A)
	Password	Administrator	(N/A)
		New Password	4
		Confirm Password	4
	SNMP	SysLocation	22
SysName		22	
SysContact		22	

Email Alert	Email Setting	To	40
		Cc	40
		Subject	15
		From	40
	SMTP Setting	Server	30
		User Name	40
		Password	14
	Alert Condition	Fan Error	(N/A)
		Lamp Error	(N/A)
		Temperature Error	(N/A)
		Submit	(N/A)
		Issue Test Mail	(N/A)

• / > < \$ % + \ ' " are prohibited.

About Crestron e-Control®

1. The Crestron e-Control® page provides a variety of virtual keys to control the projector or adjust the projected pictures.

You can press ◀/▶ to reveal more buttons.

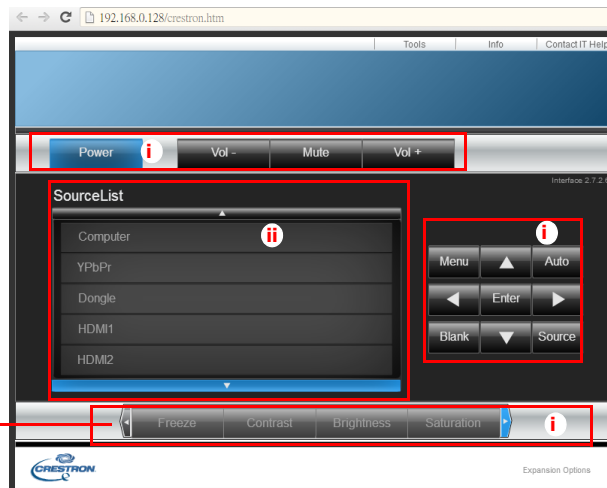

- i. These buttons function the same as the ones on the OSD menus or remote control.
- ii. To switch input source, click on your desired signal.

Important

- **The Menu button can also be used to go back to previous OSD menu, exit and save menu settings.**
- **The source list varies according to the connectors available on the projector.**
- **When you use the projector control panel or remote control to change the OSD menu settings, it may take a while for the web browser to synchronize these changes with the projector.**

2. The tools page allows you to manage the projector, configure the Lan control settings and secure access of remote network operation on this projector.

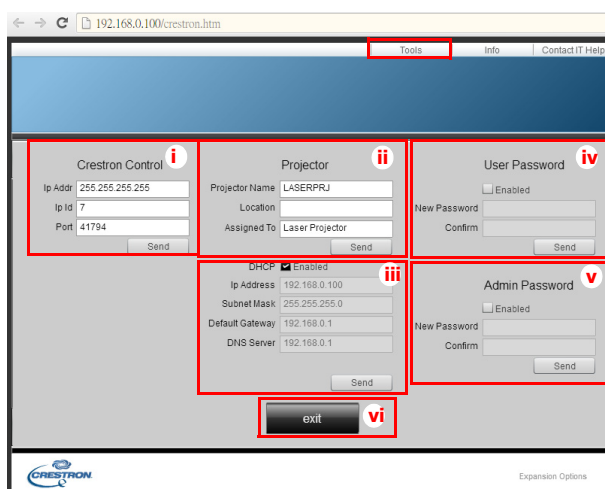

- i. This section is only used with the Crestron Control System. Please contact Creston or refer to its user manual for setup information.
 - ii. You can name the projector, keep track of its location and the person in charge of it.
 - iii. You can adjust the **Lan control setting**.
 - iv. Once set, access to the remote network operation on this projector has been password-protected.
 - v. Once set, access to the tools page has been password-protected.
- **To prevent errors, only input the English alphabet and digits on the tools page.**
 - **After making the adjustments, press the Send button and the data will be saved in the projector.**
- vi. Press **exit** to go back to the Crestron remote network operation page. Please pay attention to the limitation of input length (including space and other punctuation keys) in the list below:

Category Item	Input-Length	Maximum Number of Characters
Crestron Control	IP Address	15
	IP ID	2
	Port	5
Projector	Projector Name	10
	Location	9
	Assigned To	9
Network Configuration	DHCP (Enabled)	(N/A)
	IP Address	15
	Subnet Mask	15
	Default Gateway	15
	DNS Server	15
User Password	Enabled	(N/A)
	New Password	20
	Confirm	2
Admin Password	Enabled	(N/A)
	New Password	20
	Confirm	20

3. The info page displays the information and status of this projector.

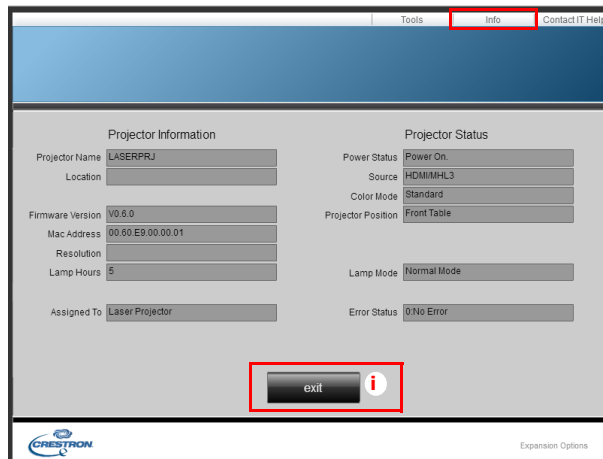

- i. Press **exit** to go back to the Crestron remote network operation page.
4. After pressing the button “Contact IT Help”, the HELP DESK window will appear in the upper right corner of the screen. You will be able to deliver messages to RoomView™ software administrators/users who connect to the same local area network.

- For more information, visit <http://www.crestron.com> & www.crestron.com/getroomview.

Crestron RoomView

On the “Edit Room” page, enter the IP Address (or hostname) as shown on the projector’s on-screen display (OSD) menu, and “02” for IPID, “41794” for the reserved Crestron control port.

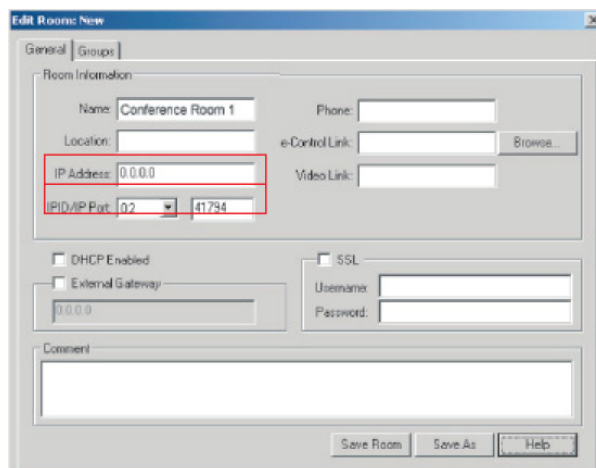

About Crestron RoomView™ setting and command method, please access below website to get RoomView™ User Guide and more information: http://www.crestron.com/products/roomview_connected_embedded_projectors_devices/resources.asp

Maintenance

The projector needs proper maintenance. You should keep the lens clean as dust, dirt or spots will project on the screen and diminish image quality. If any other parts need replacing, contact your dealer or qualified service personnel. When cleaning any part of the projector, always switch off and unplug the projector first.



Warning

- ***Never open any of the covers on the projector. Dangerous electrical voltages inside the projector can cause severe injury. Do not attempt to service this product yourself. Refer all servicing to qualified service personnel.***

Cleaning the projector housing

Gently wipe with a soft cloth. If dirt and stains are not easily removed, use a soft cloth dampened with water, or water and neutral detergent, and wipe dry with a soft, dry cloth.



Note

- ***Turn off the projector and remove the AC power cord from the power outlet before beginning maintenance work.***
- ***Make sure the lens is cool before cleaning.***
- ***Do not use detergents or chemicals other than those noted above. Do not use benzene or thinners.***
- ***Do not use chemical sprays.***
- ***Use a soft cloth or lens paper only.***

Specifications

Model name	DX761Z-UST	DW763Z-UST	DH765Z-UST
Display system	0.55" S450 XGA	0.65" S450 WXGA	0.65" S600 WXGA
Resolution	XGA (1024 x 768 pixels)	WXGA (1280 x 800 pixels)	1080p (1920 x 1080 pixels)
Aspect ratio	Native 4:3	Native 16:10	Native 16:9
Zoom ratio	Fixed		
Throw ratio	0.3	0.24	0.233
Image size (Diagonal)	80" - 150"		
Light source	Laser Phosphor Display		
Input terminal	D-Sub 15-pin x 1, HDMI x 2, S-Video x 1, Video x 1, Audio signal input (Mini jack) x 1, Audio L/R (RCA x 2) x 1		
Output terminal	D-Sub 15 pin x 1, Audio signal output (Mini jack) x 1, USB power charging (5V/2A) x 1		
Control terminal	RS-232 x 1, Mini-USB x1 (for service), RJ45 x 1		
Speaker	10W x 1		
HDTV compatibility	480i, 480p, 576i, 567p, 720p, 1080i, 1080p		
Video compatibility	NTSC, PAL, SECAM, SDTV (480i/576i), EDTV (480p/576p), HDTV (720p, 1080i/p 60Hz)		
Scanning frequency	15 - 102 KHz		
Horizontal frequency	23 - 120 Hz		
Vertical frequency			
Environment	Operating: Temperature: 0°C to 40°C Humidity: 10%-90% Storage: Temperature: -20°C to 60°C Humidity: 10%-90%		
Power requirement	100-240 Vac, 50-60 Hz, 5.20A		
Power consumption	380W (Max.)		
Stand-by power consumption	< 0.50W		
Dimension (W x H x D)	508.7 x 144.5 x 390.0 mm		
Weight	10.5 kg (23.14 lbs)		
Note: Design and Specifications are subject to change without prior notice.			

Dimensions

508.7 mm (W) x 390.0 mm (D) x 144.5 mm (H)

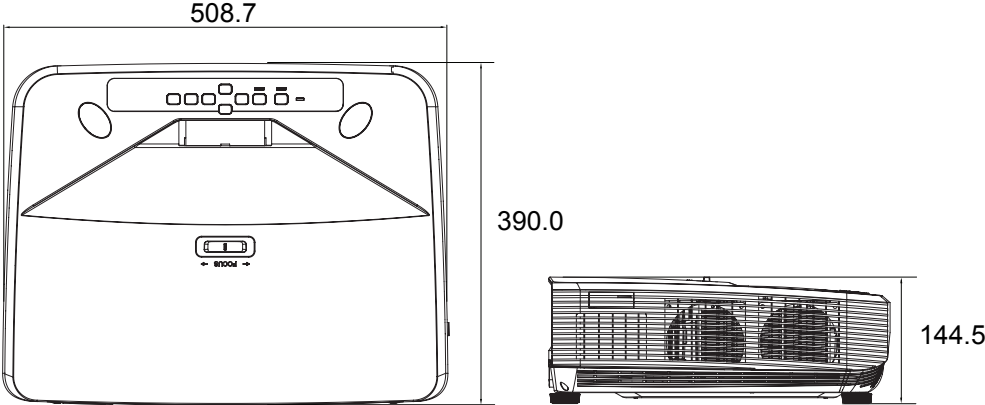

Ceiling mount installation

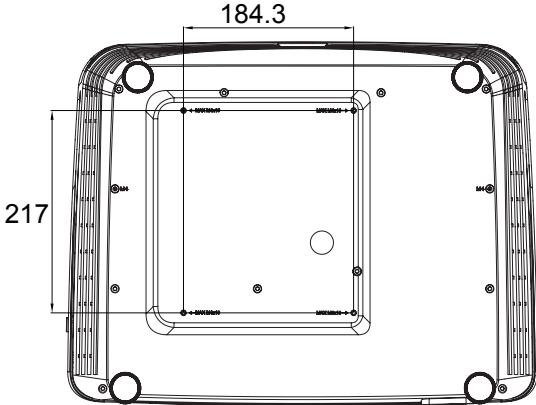

Ceiling mount screws:
Max. M4 x 10

Unit: mm

Appendices

LED indicator messages

LED Type	Color	Status	Meaning
Power LED	Amber	Flash	Normal power of standby mode .
Temp LED	Red	Off	
Light LED	Red	Off	
Power LED	Amber	Flash	Low power of standby mode.
Temp LED	Red	Off	
Light LED	Red	Off	
Power LED	Amber	Flash	Powering up
Temp LED	Red	Off	
Light LED	Red	Off	
Power LED	Green	Solid	Normal operation
Temp LED	Red	Off	
Light LED	Red	Off	
Power LED	Green	Solid	Powering down
Temp LED	Red	Off	
Light LED	Red	Off	
Power LED	Amber	Solid	If the projector system has some problems with its fans, the projector will shut down.
Temp LED	Red	Off	
Light LED	Red	Off	
Power LED	Amber	Solid	1. Temperature is too high. The light will turn off. The fan motor is cooling the light. Or 2. The cooling process is not complete after the projector is shut down and re-started right away.
Temp LED	Red	Flash	
Light LED	Red	Off	
Power LED	Amber	Flash	The light ignition failed. If temperature is too high, the fans will cool the light.
Temp LED	Red	Off	
Light LED	Red	Solid	
Power LED	Amber	Solid	Color wheel start fail
Temp LED	Red	Solid	
Light LED	Red	Solid	

Compatibility Modes

1. VGA Analog

Supported timing for PC input

Resolution	Timing	Horizontal frequency (KHz)	Vertical frequency (Hz)	Pixel Frequency (MHz)	3D Field Sequential	3D top bottom	3D side by side
640 x 480	VGA_60	59.94	31.469	25.175	⊙	⊙	⊙
	VGA_72	72.809	37.861	31.500			
	VGA_75	75	37.5	31.500			
	VGA_85	85.008	43.269	36.000			
720 x 400	720 x 400_70	70.087	31.469	28.3221			
800 x 600	SVGA_60	60.317	37.879	40.000	⊙	⊙	⊙
	SVGA_72	72.188	48.077	50.000			
	SVGA_75	75	46.875	49.500			
	SVGA_85	85.061	53.674	56.250			
	SVGA_120 (Reduce Blanking)	119.854	77.425	83.000	⊙		
1024 x 768	XGA_60	60.004	48.363	65.000	⊙	⊙	⊙
	XGA_70	70.069	56.476	75.000			
	XGA_75	75.029	60.023	78.750			
	XGA_85	84.997	68.667	94.500			
	XGA_120 (Reduce Blanking)	119.989	97.551	115.5	⊙		
1152 x 864	1152 x 864_75	75	67.5	108			
1280 x 720	1280 x 720_60	60	45	74.250	⊙	⊙	⊙
	1280 x 720_120	120	90.000	148.500	⊙		
1280 x 768	1280 x 768_60	59.87	47.776	79.5	⊙	⊙	⊙
1280 x 800	WXGA_60	59.81	49.702	83.500	⊙	⊙	⊙
	WXGA_75	74.934	62.795	106.500			
	WXGA_85	84.88	71.554	122.500			
	WXGA_120 (Reduce Blanking)	119.909	101.563	146.25	⊙		
1280 x 1024	SXGA_60	60.02	63.981	108.000		⊙	⊙
	SXGA_75	75.025	79.976	135.000			
	SXGA_85	85.024	91.146	157.500			
1280 x 960	1280 x 960_60	60	60	108.000		⊙	⊙
	1280 x 960_85	85.002	85.938	148.500			
1360 x 768	1360 x 768_60	60.015	47.712	85.5		⊙	⊙
1440 x 900	WXGA+_60	59.887	55.935	106.500		⊙	⊙
1400 x 1050	SXGA+_60	59.978	65.317	121.750		⊙	⊙
1600 x 1200	UXGA	60	75	162.000		⊙	⊙

1680 x 1050	1680 x 1050_60	59.954	65.29	146.25		⊙	⊙
1920 x 1080	1920 x 1080_60 (Reduce Blanking)	67.5	60	148.5			
1920 x 1200	1920 x 1200_60 (Reduce Blanking)	59.95	74.038	154.000			
640 x 480 @67Hz	MAC13	66.667	35	30.240			
832 x 624 @75Hz	MAC16	74.546	49.722	57.280			
1024 x 768 @75Hz	MAC19	75.02	60.241	80.000			
1152 x 870 @75Hz	MAC21	75.06	68.68	100.000			

- The timings showing above may not be supported due to EDID file and VGA graphic card limitations. It is possible that some timings cannot be chosen.

Supported timing for Component-YPbPr input

Timing	Resolution	Horizontal Frequency (KHz)	Vertical Frequency (Hz)	Pixel Frequency (MHz)	3D Field Sequential
480i	720 x 480	15.73	59.94	13.5	⊙
480p	720 x 480	31.47	59.94	27	⊙
576i	720 x 576	15.63	50	13.5	
576p	720 x 576	31.25	50	27	
720/50p	1280 x 720	37.5	50	74.25	
720/60p	1280 x 720	45.00	60	74.25	⊙
1080/50i	1920 x 1080	28.13	50	74.25	
1080/60i	1920 x 1080	33.75	60	74.25	
1080/24P	1920 x 1080	27	24	74.25	
1080/25P	1920 x 1080	28.13	25	74.25	
1080/30P	1920 x 1080	33.75	30	74.25	
1080/50P	1920 x 1080	56.25	50	148.5	
1080/60P	1920 x 1080	67.5	60	148.5	

2. HDMI Digital

Supported timing for PC input

Resolution	Timing	Horizontal Frequency (KHz)	Vertical Frequency (Hz)	Pixel Frequency (MHz)	3D Field Sequential	3D top bottom	3D side by side
640 x 480	VGA_60	59.94	31.469	25.175	⊙	⊙	⊙
	VGA_72	72.809	37.861	31.500			
	VGA_75	75	37.5	31.500			
	VGA_85	85.008	43.269	36.000			
720 x 400	720 x 400_70	70.087	31.469	28.3221			

800 x 600	SVGA_60	60.317	37.879	40.000	◎	◎	◎
	SVGA_72	72.188	48.077	50.000			
	SVGA_75	75	46.875	49.500			
	SVGA_85	85.061	53.674	56.250			
	SVGA_120 (Reduce Blanking)	119.854	77.425	83.000	◎		
1024 x 768	XGA_60	60.004	48.363	65.000	◎	◎	◎
	XGA_70	70.069	56.476	75.000			
	XGA_75	75.029	60.023	78.750			
	XGA_85	84.997	68.667	94.500			
	XGA_120 (Reduce Blanking)	119.989	97.551	115.5	◎		
1152 x 864	1152 x 864_75	75	67.5	108			
1280 x 720	1280 x 720_60	60	45	74.250	◎	◎	◎
1280 x 768	1280 x 768_60	59.87	47.776	79.5	◎	◎	◎
1280 x 800	WXGA_60	59.81	49.702	83.500	◎	◎	◎
	WXGA_75	74.934	62.795	106.500			
	WXGA_85	84.88	71.554	122.500			
	WXGA_120 (Reduce Blanking)	119.909	101.563	146.25	◎		
1280 x 1024	SXGA_60	60.02	63.981	108.000		◎	◎
	SXGA_75	75.025	79.976	135.000			
	SXGA_85	85.024	91.146	157.500			
1280 x 960	1280 x 960_60	60	60	108.000		◎	◎
	1280 x 960_85	85.002	85.938	148.500			
1360 x 768	1360 x 768_60	60.015	47.712	85.5		◎	◎
1440 x 900	WXGA+_6 0	59.887	55.935	106.500		◎	◎
1400 x 1050	SXGA+_60	59.978	65.317	121.750		◎	◎
1600 x 1200	UXGA	60	75	162.000		◎	◎
1680 x 1050	1680 x 1050_60	59.954	65.29	146.25		◎	◎
640 x 480 @67Hz	MAC13	66.667	35	30.240			
832 x 624 @75Hz	MAC16	74.546	49.722	57.280			
1024 x 768 @75Hz	MAC19	75.02	60.241	80.000			
1152 x 870 @75Hz	MAC21	75.06	68.68	100.000			
1920 x 1080	1920 x 1080_60 (Reduce Blanking)	67.5	60	148.5			
1920 x 1200	1920 x 1200_60 (Reduce Blanking)	59.95	74.038	154.000			

- The timings showing above may not be supported due to EDID file and VGA graphic card limitations. It is possible that some timings cannot be chosen.

Supported timing for video input

Timing	Resolution	Horizontal Frequency (KHz)	Vertical Frequency (Hz)	Pixel Frequency (MHz)	3D Field Sequential	3D Frame Packing	3D Top-Bottom	3D Side by Side
480i	720 (1440) x 480	15.73	59.94	27	⊙			
480p	720 x 480	31.47	59.94	27	⊙			
576i	720 (1440) x 576	15.63	50	27				
576p	720 x 576	31.25	50	27				
720/50p	1280 x 720	37.5	50	74.25		⊙	⊙	⊙
720/60p	1280 x 720	45.00	60	74.25	⊙	⊙	⊙	⊙
1080/50i	1920 x 1080	28.13	50	74.25				⊙
1080/60i	1920 x 1080	33.75	60	74.25				⊙
1080/24P	1920 x 1080	27	24	74.25		⊙	⊙	⊙
1080/25P	1920 x 1080	28.13	25	74.25				
1080/30P	1920 x 1080	33.75	30	74.25				
1080/50P	1920 x 1080	56.25	50	148.5			⊙	⊙
1080/60P	1920 x 1080	67.5	60	148.5			⊙	⊙

3. Video/S-Video

Supported timing for Video input

Video mode	Horizontal Frequency (kHz)	Vertical Frequency (Hz)	Color sub-carrier Frequency (MHz)	3D Field Sequential
NTSC	15.73	60	3.58	⊙
PAL	15.63	50	4.43	
SECAM	15.63	50	4.25 or 4.41	
PAL-M	15.73	60	3.58	
PAL-N	15.63	50	3.58	
PAL-60	15.73	60	4.43	
NTSC4.43	15.73	60	4.43	

Troubleshooting

Refer to the symptoms and measures listed below before sending the projector for repairs. If the problem persists, contact your local reseller or service center. Please refer to "LED Indicator Messages" as well.

Start-up problems

If no lights turn on:

- Be sure that the power cord is securely connected to the projector and the other end is plugged into an outlet with power.
- Press the power button again.
- Unplug the power cord and wait for a short while, then plug it in and press the power button again.

Image problems

If the searching source is displayed:

- Press **Source** to select an active input source.
- Be sure the external source is turned on and connected.
- For a computer connection, ensure your notebook computer's external video port is turned on. Refer to the computer manual.

If the image is out of focus:

- While displaying the on-screen menu, adjust the focus ring. (The image size should not change; if it does, you are adjusting the zoom, not the focus.)
- Check the projection lens to see if it needs cleaning.
- If the image is flickering or unstable for a computer connection:
- Press **Menu**, go to **DISPLAY** and adjust **Phase** or **H. Size**.

Remote control problems

If the remote control does not operate:

- Be sure nothing is blocking the remote control receiver on the front of the projector. Use the remote control within the effective range.
- Aim the remote control at the screen or at the front of the projector.
- Move the remote control so it is more directly in front of the projector and not as far to the side.

RS-232 command and configuration

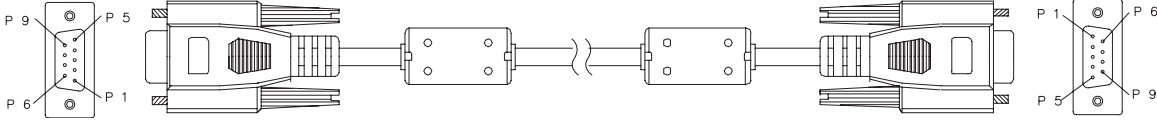

D-Sub 9 pin

1	1 CD
2	RXD
3	TXD
4	DTR
5	GND
6	DSR
7	RTS
8	CTS
9	RI

Wire List

C1	COLOR	C2
1	Black	1
2	Brown	3
3	Red	2
4	Orange	6
5	Yellow	5
6	Green	4
7	Blue	8
8	Purple	7
9	White	9
SHELL	DW	SHELL

Baud Rate	115200 bps
Data Length	8 bit
Parity Check	None
Stop Bit	1 bit
Flow Control	None

Function	Status	Action	cmd
Power	Write	Power on	0x06 0x14 0x00 0x04 0x00 0x34 0x11 0x00 0x00 0x5D
		Power off	0x06 0x14 0x00 0x04 0x00 0x34 0x11 0x01 0x00 0x5E
	Read	Power status (on/off)	0x07 0x14 0x00 0x05 0x00 0x34 0x00 0x00 0x11 0x00 0x5E
Reset all settings		Execute	0x06 0x14 0x00 0x04 0x00 0x34 0x11 0x02 0x00 0x5F
Reset Color Settings		Execute	0x06 0x14 0x00 0x04 0x00 0x34 0x11 0x2A 0x00 0x87
Splash Screen	Write	Splash Screen Black	0x06 0x14 0x00 0x04 0x00 0x34 0x11 0x0A 0x00 0x67
		Splash Screen Blue	0x06 0x14 0x00 0x04 0x00 0x34 0x11 0x0A 0x01 0x68
		Splash Screen default	0x06 0x14 0x00 0x04 0x00 0x34 0x11 0x0A 0x02 0x69
		Splash Screen Off	0x06 0x14 0x00 0x04 0x00 0x34 0x11 0x0A 0x04 0x6B
	Read	Splash Screen status	0x07 0x14 0x00 0x05 0x00 0x34 0x00 0x00 0x11 0x0A 0x68
Quick Power Off	Write	Quick Power Off Off	0x06 0x14 0x00 0x04 0x00 0x34 0x11 0x0B 0x00 0x68
		Quick Power Off On	0x06 0x14 0x00 0x04 0x00 0x34 0x11 0x0B 0x01 0x69
	Read	Quick Power Off status	0x07 0x14 0x00 0x05 0x00 0x34 0x00 0x00 0x11 0x0B 0x69
High Altitude Mode	Write	High Altitude Mode Off	0x06 0x14 0x00 0x04 0x00 0x34 0x11 0x0C 0x00 0x69
		High Altitude Mode On	0x06 0x14 0x00 0x04 0x00 0x34 0x11 0x0C 0x01 0x6A
	Read	High Altitude Mode status	0x07 0x14 0x00 0x05 0x00 0x34 0x00 0x00 0x11 0x0C 0x6A
Light Mode	Write	Normal	0x06 0x14 0x00 0x04 0x00 0x34 0x11 0x10 0x00 0x6D
		Economic	0x06 0x14 0x00 0x04 0x00 0x34 0x11 0x10 0x01 0x6E
	Read	Light Mode status	0x07 0x14 0x00 0x05 0x00 0x34 0x00 0x00 0x11 0x10 0x6E
Message	Write	Message Off	0x06 0x14 0x00 0x04 0x00 0x34 0x11 0x27 0x00 0x84
		Message On	0x06 0x14 0x00 0x04 0x00 0x34 0x11 0x27 0x01 0x85
	Read	Message status	0x07 0x14 0x00 0x05 0x00 0x34 0x00 0x00 0x11 0x27 0x85
Projector Position	Write	Front Table	0x06 0x14 0x00 0x04 0x00 0x34 0x12 0x00 0x00 0x5E
		Rear Table	0x06 0x14 0x00 0x04 0x00 0x34 0x12 0x00 0x01 0x5F
		Rear Ceiling	0x06 0x14 0x00 0x04 0x00 0x34 0x12 0x00 0x02 0x60
		Front Ceiling	0x06 0x14 0x00 0x04 0x00 0x34 0x12 0x00 0x03 0x61
	Read	Projector position status	0x07 0x14 0x00 0x05 0x00 0x34 0x00 0x00 0x12 0x00 0x5F
3D Sync	Write	OFF	0x06 0x14 0x00 0x04 0x00 0x34 0x12 0x20 0x00 0x7E
		Auto	0x06 0x14 0x00 0x04 0x00 0x34 0x12 0x20 0x01 0x7F
		Frame Sequential	0x06 0x14 0x00 0x04 0x00 0x34 0x12 0x20 0x02 0x80
		Frame Packing	0x06 0x14 0x00 0x04 0x00 0x34 0x12 0x20 0x03 0x81
		Top-Bottom	0x06 0x14 0x00 0x04 0x00 0x34 0x12 0x20 0x04 0x82
		Side-by-Side	0x06 0x14 0x00 0x04 0x00 0x34 0x12 0x20 0x05 0x83
	Read	3D Sync Status	0x07 0x14 0x00 0x05 0x00 0x34 0x00 0x00 0x12 0x20 0x7F
3D Sync Invert	Write	Off	0x06 0x14 0x00 0x04 0x00 0x34 0x12 0x21 0x00 0x7F
		On	0x06 0x14 0x00 0x04 0x00 0x34 0x12 0x21 0x01 0x80
	Read	3D Sync Invert Status	0x07 0x14 0x00 0x05 0x00 0x34 0x00 0x00 0x12 0x21 0x80
Contrast	Write	Contrast decrease	0x06 0x14 0x00 0x04 0x00 0x34 0x12 0x02 0x00 0x60
		Contrast increase	0x06 0x14 0x00 0x04 0x00 0x34 0x12 0x02 0x01 0x61
	Read	Contrast ratio	0x07 0x14 0x00 0x05 0x00 0x34 0x00 0x00 0x12 0x02 0x61

Brightness	Write	Brightness decrease	0x06 0x14 0x00 0x04 0x00 0x34 0x12 0x03 0x00 0x61
		Brightness increase	0x06 0x14 0x00 0x04 0x00 0x34 0x12 0x03 0x01 0x62
	Read	Brightness	0x07 0x14 0x00 0x05 0x00 0x34 0x00 0x00 0x12 0x03 0x62
Aspect ratio	Write	Aspect ratio Auto	0x06 0x14 0x00 0x04 0x00 0x34 0x12 0x04 0x00 0x62
		Aspect ratio 4:3	0x06 0x14 0x00 0x04 0x00 0x34 0x12 0x04 0x02 0x64
		Aspect ratio 16:9	0x06 0x14 0x00 0x04 0x00 0x34 0x12 0x04 0x03 0x65
		Aspect ratio 16:10	0x06 0x14 0x00 0x04 0x00 0x34 0x12 0x04 0x04 0x66
		Aspect ratio Anamorphic	0x06 0x14 0x00 0x04 0x00 0x34 0x12 0x04 0x06 0x68
		Aspect ratio Wide	0x06 0x14 0x00 0x04 0x00 0x34 0x12 0x04 0x06 0x68
		Aspect ratio 2.35:1	0x06 0x14 0x00 0x04 0x00 0x34 0x12 0x04 0x07 0x69
	Aspect ratio 16:6	0x06 0x14 0x00 0x04 0x00 0x34 0x12 0x04 0x08 0x6A	
	Read	Aspect ratio	0x07 0x14 0x00 0x05 0x00 0x34 0x00 0x00 0x12 0x04 0x63
Auto Adjust		Execute	0x06 0x14 0x00 0x04 0x00 0x34 0x12 0x05 0x00 0x63
Horizontal position	Write	Horizontal position shift right	0x06 0x14 0x00 0x04 0x00 0x34 0x12 0x06 0x01 0x65
		Horizontal position shift left	0x06 0x14 0x00 0x04 0x00 0x34 0x12 0x06 0x00 0x64
	Read	Horizontal position	0x07 0x14 0x00 0x05 0x00 0x34 0x00 0x00 0x12 0x06 0x65
Vertical position	Write	Vertical position shift up	0x06 0x14 0x00 0x04 0x00 0x34 0x12 0x07 0x00 0x65
		Vertical position shift down	0x06 0x14 0x00 0x04 0x00 0x34 0x12 0x07 0x01 0x66
	Read	read Vertical position	0x07 0x14 0x00 0x05 0x00 0x34 0x00 0x00 0x12 0x07 0x66
Color temperature	Write	color temperature Warm	0x06 0x14 0x00 0x04 0x00 0x34 0x12 0x08 0x00 0x66
		color temperature Normal	0x06 0x14 0x00 0x04 0x00 0x34 0x12 0x08 0x01 0x67
		color temperature Neutral	0x06 0x14 0x00 0x04 0x00 0x34 0x12 0x08 0x02 0x68
		color temperature Cool	0x06 0x14 0x00 0x04 0x00 0x34 0x12 0x08 0x03 0x69
	Read	color temperature status	0x07 0x14 0x00 0x05 0x00 0x34 0x00 0x00 0x12 0x08 0x67
Blank	Write	Blank On	0x06 0x14 0x00 0x04 0x00 0x34 0x12 0x09 0x01 0x68
		Blank Off	0x06 0x14 0x00 0x04 0x00 0x34 0x12 0x09 0x00 0x67
	Read	Blank status	0x07 0x14 0x00 0x05 0x00 0x34 0x00 0x00 0x12 0x09 0x68
Keystone-Vertical	Write	Decrease	0x06 0x14 0x00 0x04 0x00 0x34 0x11 0x31 0x00 0x8E
		Increase	0x06 0x14 0x00 0x04 0x00 0x34 0x11 0x31 0x01 0x8F
	Read	Keystone status	0x07 0x14 0x00 0x05 0x00 0x34 0x00 0x00 0x11 0x31 0x8F
Keystone-Horizontal	Write	Decrease	0x06 0x14 0x00 0x04 0x00 0x34 0x11 0x31 0x00 0x8E
		Increase	0x06 0x14 0x00 0x04 0x00 0x34 0x11 0x31 0x01 0x8F
	Read	Keystone status	0x07 0x14 0x00 0x05 0x00 0x34 0x00 0x00 0x11 0x31 0x8F
Color mode	Write	Brightest	0x06 0x14 0x00 0x04 0x00 0x34 0x12 0x0B 0x00 0x69
		PC	0x06 0x14 0x00 0x04 0x00 0x34 0x12 0x0B 0x08 0x71
		Video	0x06 0x14 0x00 0x04 0x00 0x34 0x12 0x0B 0x04 0x6D
	Read	Preset mode status	0x07 0x14 0x00 0x05 0x00 0x34 0x00 0x00 0x12 0x0B 0x6A

Primary Color	Write	Primary color R	0x06 0x14 0x00 0x04 0x00 0x34 0x12 0x10 0x00 0x6E
		Primary color G	0x06 0x14 0x00 0x04 0x00 0x34 0x12 0x10 0x01 0x6F
		Primary color B	0x06 0x14 0x00 0x04 0x00 0x34 0x12 0x10 0x02 0x70
		Primary color C	0x06 0x14 0x00 0x04 0x00 0x34 0x12 0x10 0x03 0x71
		Primary color M	0x06 0x14 0x00 0x04 0x00 0x34 0x12 0x10 0x04 0x72
		Primary color Y	0x06 0x14 0x00 0x04 0x00 0x34 0x12 0x10 0x05 0x73
	Read	Primary color status	0x07 0x14 0x00 0x05 0x00 0x34 0x00 0x00 0x12 0x10 0x6F
Hue	Write	Hue decrease	0x06 0x14 0x00 0x04 0x00 0x34 0x12 0x11 0x00 0x6F
		Hue increase	0x06 0x14 0x00 0x04 0x00 0x34 0x12 0x11 0x01 0x70
	Read	Hue	0x07 0x14 0x00 0x05 0x00 0x34 0x00 0x00 0x12 0x11 0x70
Saturation	Write	Saturation decrease	0x06 0x14 0x00 0x04 0x00 0x34 0x12 0x12 0x00 0x70
		Saturation increase	0x06 0x14 0x00 0x04 0x00 0x34 0x12 0x12 0x01 0x71
	Read	Saturation	0x07 0x14 0x00 0x05 0x00 0x34 0x00 0x00 0x12 0x12 0x71
Gain	Write	Gain decrease	0x06 0x14 0x00 0x04 0x00 0x34 0x12 0x13 0x00 0x71
		Gain increase	0x06 0x14 0x00 0x04 0x00 0x34 0x12 0x13 0x01 0x72
	Read	Gain	0x07 0x14 0x00 0x05 0x00 0x34 0x00 0x00 0x12 0x13 0x72
Freeze	Write	Freeze On	0x06 0x14 0x00 0x04 0x00 0x34 0x13 0x00 0x01 0x60
		Freeze Off	0x06 0x14 0x00 0x04 0x00 0x34 0x13 0x00 0x00 0x5F
	Read	Freeze status	0x07 0x14 0x00 0x05 0x00 0x34 0x00 0x00 0x13 0x00 0x60
Source input	Write	Input source VGA	0x06 0x14 0x00 0x04 0x00 0x34 0x13 0x01 0x00 0x60
		Input source YPbPr	0x06 0x14 0x00 0x04 0x00 0x34 0x13 0x01 0x08 0x68
		SourceSelectDongle	0x06 0x14 0x00 0x04 0x00 0x34 0x13 0x01 0x03 0x63
		SourceSelectHDMI1	0x06 0x14 0x00 0x04 0x00 0x34 0x13 0x01 0x07 0x67
		SourceSelectHDMI2	0x06 0x14 0x00 0x04 0x00 0x34 0x13 0x01 0x04 0x64
		SourceSelectHDMI3	0x06 0x14 0x00 0x04 0x00 0x34 0x13 0x01 0x09 0x69
		Input source Composite	0x06 0x14 0x00 0x04 0x00 0x34 0x13 0x01 0x05 0x65
	Input source SVIDEO	0x06 0x14 0x00 0x04 0x00 0x34 0x13 0x01 0x06 0x66	
	Read	Source	0x07 0x14 0x00 0x05 0x00 0x34 0x00 0x00 0x13 0x01 0x61
Quick Auto Search	Write	Quick Auto Search on	0x06 0x14 0x00 0x04 0x00 0x34 0x13 0x02 0x01 0x62
		Quick Auto Search off	0x06 0x14 0x00 0x04 0x00 0x34 0x13 0x02 0x00 0x61
	Read	Quick Auto Search status	0x07 0x14 0x00 0x05 0x00 0x34 0x00 0x00 0x13 0x02 0x62
Mute	Write	Mute on	0x06 0x14 0x00 0x04 0x00 0x34 0x14 0x00 0x01 0x61
		Mute off	0x06 0x14 0x00 0x04 0x00 0x34 0x14 0x00 0x00 0x60
	Read	Mute status	0x07 0x14 0x00 0x05 0x00 0x34 0x00 0x00 0x14 0x00 0x61
Volume	Write	Increase Volume	0x06 0x14 0x00 0x04 0x00 0x34 0x14 0x01 0x00 0x61
		Decrease Volume	0x06 0x14 0x00 0x04 0x00 0x34 0x14 0x02 0x00 0x62
	Read	Volume	0x07 0x14 0x00 0x05 0x00 0x34 0x00 0x00 0x14 0x03 0x64

Language	Write	English	0x06 0x14 0x00 0x04 0x00 0x34 0x15 0x00 0x00 0x61
		Français	0x06 0x14 0x00 0x04 0x00 0x34 0x15 0x00 0x01 0x62
		Deutsch	0x06 0x14 0x00 0x04 0x00 0x34 0x15 0x00 0x02 0x63
		Italiano	0x06 0x14 0x00 0x04 0x00 0x34 0x15 0x00 0x03 0x64
		Español	0x06 0x14 0x00 0x04 0x00 0x34 0x15 0x00 0x04 0x65
		Русский	0x06 0x14 0x00 0x04 0x00 0x34 0x15 0x00 0x05 0x66
		繁體中文	0x06 0x14 0x00 0x04 0x00 0x34 0x15 0x00 0x06 0x67
		简体中文	0x06 0x14 0x00 0x04 0x00 0x34 0x15 0x00 0x07 0x68
		日本語	0x06 0x14 0x00 0x04 0x00 0x34 0x15 0x00 0x08 0x69
		한국어	0x06 0x14 0x00 0x04 0x00 0x34 0x15 0x00 0x09 0x6A
		Svenska	0x06 0x14 0x00 0x04 0x00 0x34 0x15 0x00 0x0a 0x6B
		Nederlands	0x06 0x14 0x00 0x04 0x00 0x34 0x15 0x00 0x0b 0x6C
		Türkçe	0x06 0x14 0x00 0x04 0x00 0x34 0x15 0x00 0x0c 0x6D
		Čeština	0x06 0x14 0x00 0x04 0x00 0x34 0x15 0x00 0x0d 0x6D
		Português	0x06 0x14 0x00 0x04 0x00 0x34 0x15 0x00 0x0e 0x6F
		ไทย	0x06 0x14 0x00 0x04 0x00 0x34 0x15 0x00 0x0f 0x70
		Polski	0x06 0x14 0x00 0x04 0x00 0x34 0x15 0x00 0x10 0x71
		Suomi	0x06 0x14 0x00 0x04 0x00 0x34 0x15 0x00 0x11 0x72
		العربية	0x06 0x14 0x00 0x04 0x00 0x34 0x15 0x00 0x12 0x73
	Indonesia	0x06 0x14 0x00 0x04 0x00 0x34 0x15 0x00 0x13 0x74	
हिन्दी	0x06 0x14 0x00 0x04 0x00 0x34 0x15 0x00 0x14 0x75		
	Read	Language	0x07 0x14 0x00 0x05 0x00 0x34 0x00 0x00 0x15 0x00 0x62
Light Time	Write	Reset Light usage hour	0x06 0x14 0x00 0x04 0x00 0x34 0x15 0x01 0x00 0x62
	Read	Light usage hour	0x07 0x14 0x00 0x05 0x00 0x34 0x00 0x00 0x15 0x01 0x63
HDMI Format	Write	RGB	0x06 0x14 0x00 0x04 0x00 0x34 0x11 0x28 0x00 0x85
		YUV	0x06 0x14 0x00 0x04 0x00 0x34 0x11 0x28 0x01 0x86
		Auto	0x06 0x14 0x00 0x04 0x00 0x34 0x11 0x28 0x02 0x87
	Read	HDMI Format status	0x07 0x14 0x00 0x05 0x00 0x34 0x00 0x00 0x11 0x28 0x86
HDMI Range	Write	Enhanced	0x06 0x14 0x00 0x04 0x00 0x34 0x11 0x29 0x00 0x86
		Normal	0x06 0x14 0x00 0x04 0x00 0x34 0x11 0x29 0x01 0x87
		Auto	0x06 0x14 0x00 0x04 0x00 0x34 0x11 0x29 0x02 0x88
	Read	HDMI Range status	0x07 0x14 0x00 0x05 0x00 0x34 0x00 0x00 0x11 0x29 0x87
CEC	Write	Off	0x06 0x14 0x00 0x04 0x00 0x34 0x11 0x2B 0x00 0x88
		On	0x06 0x14 0x00 0x04 0x00 0x34 0x11 0x2B 0x01 0x89
	Read	CEC status	0x07 0x14 0x00 0x05 0x00 0x34 0x00 0x00 0x11 0x2B 0x89
Error status	Read	Read error status	0x07 0x14 0x00 0x05 0x00 0x34 0x00 0x00 0x0C 0x0D 0x66
Brilliant Color	Write	Brilliant Color 0	0x06 0x14 0x00 0x04 0x00 0x34 0x12 0x0F 0x00 0x6D
		Brilliant Color 1	0x06 0x14 0x00 0x04 0x00 0x34 0x12 0x0F 0x01 0x6E
		Brilliant Color 2	0x06 0x14 0x00 0x04 0x00 0x34 0x12 0x0F 0x02 0x6F
		Brilliant Color 3	0x06 0x14 0x00 0x04 0x00 0x34 0x12 0x0F 0x03 0x70
		Brilliant Color 4	0x06 0x14 0x00 0x04 0x00 0x34 0x12 0x0F 0x04 0x71
		Brilliant Color 5	0x06 0x14 0x00 0x04 0x00 0x34 0x12 0x0F 0x05 0x72
		Brilliant Color 6	0x06 0x14 0x00 0x04 0x00 0x34 0x12 0x0F 0x06 0x73
		Brilliant Color 7	0x06 0x14 0x00 0x04 0x00 0x34 0x12 0x0F 0x07 0x74
		Brilliant Color 8	0x06 0x14 0x00 0x04 0x00 0x34 0x12 0x0F 0x08 0x75
		Brilliant Color 9	0x06 0x14 0x00 0x04 0x00 0x34 0x12 0x0F 0x09 0x76
	Brilliant Color 10	0x06 0x14 0x00 0x04 0x00 0x34 0x12 0x0F 0x0A 0x77	
	Read	Brilliant Color status	0x07 0x14 0x00 0x05 0x00 0x34 0x00 0x00 0x12 0x0F 0x6E

Screen Color	Write	Screen color Off	0x06 0x14 0x00 0x04 0x00 0x34 0x11 0x32 0x00 0x8F
		Blackboard	0x06 0x14 0x00 0x04 0x00 0x34 0x11 0x32 0x01 0x90
		Greenboard	0x06 0x14 0x00 0x04 0x00 0x34 0x11 0x32 0x02 0x91
		Whiteboard	0x06 0x14 0x00 0x04 0x00 0x34 0x11 0x32 0x03 0x92
	Read	Screen Color status	0x07 0x14 0x00 0x05 0x00 0x34 0x00 0x00 0x11 0x32 0x90
Over Scan	Write	Overscan Off	0x06 0x14 0x00 0x04 0x00 0x34 0x11 0x33 0x00 0x90
		Overscan 1	0x06 0x14 0x00 0x04 0x00 0x34 0x11 0x33 0x01 0x91
		Overscan 2	0x06 0x14 0x00 0x04 0x00 0x34 0x11 0x33 0x02 0x92
		Overscan 3	0x06 0x14 0x00 0x04 0x00 0x34 0x11 0x33 0x03 0x93
		Overscan 4	0x06 0x14 0x00 0x04 0x00 0x34 0x11 0x33 0x04 0x94
		Overscan 5	0x06 0x14 0x00 0x04 0x00 0x34 0x11 0x33 0x05 0x95
	Read	Overscan status	0x07 0x14 0x00 0x05 0x00 0x34 0x00 0x00 0x11 0x33 0x91
Remote Key	Write	Menu	0x02 0x14 0x00 0x04 0x00 0x34 0x02 0x04 0x0F 0x61
		Exit	0x02 0x14 0x00 0x04 0x00 0x34 0x02 0x04 0x13 0x65
		Top	0x02 0x14 0x00 0x04 0x00 0x34 0x02 0x04 0x0B 0x5D
		Bottom	0x02 0x14 0x00 0x04 0x00 0x34 0x02 0x04 0x0C 0x5E
		Left	0x02 0x14 0x00 0x04 0x00 0x34 0x02 0x04 0x0D 0x5F
		Right	0x02 0x14 0x00 0x04 0x00 0x34 0x02 0x04 0x0E 0x60
		Source	0x02 0x14 0x00 0x04 0x00 0x34 0x02 0x04 0x04 0x56
		Enter	0x02 0x14 0x00 0x04 0x00 0x34 0x02 0x04 0x15 0x67
		Auto	0x02 0x14 0x00 0x04 0x00 0x34 0x02 0x04 0x08 0x5A
		My Button	0x02 0x14 0x00 0x04 0x00 0x34 0x02 0x04 0x11 0x63