



Wireless Microphones
Wireless Receiver



Table of Contents

- 1. Before You Get Started..... 3
- 2. How It Works 3
- 3. Compatible Accessories..... 4
- 4. Rack Mounting 5
- 5. Wireless Receiver..... 6
- 6. Wireless Transmitter and Receiver Adjustments..... 7
- 7. Body-pack Transmitter 8
- 8. Lavalier Microphone..... 9
- 9. Headset Microphones..... 10
- 10. Lavalier Microphone..... 11
- 11. Specifications 12

Compliance statement:

This device complies with part 15 of the FCC Rules. Operation is subject to the following two conditions: (1) This device may not cause harmful interference, and (2) this device must accept any interference received, including interference that may cause undesired operation.

Caution:

Changes or modifications not expressly approved by the party responsible for compliance could void the user’s authority to operate the equipment.



1-Year Limited Warranty

This Sense™ Product has a One-Year Limited Warranty. This warranty includes parts and labor repairs on all components found to be defective in material or workmanship under normal conditions of use. This warranty shall not apply to products that have been abused, modified, or disassembled. Products to be repaired under this warranty must be returned to SnapAV or a designated service center with prior notification and an assigned return authorization number (RA).



1. Before You Get Started

Sense microphones deliver excellent sound reproduction when and where you need it most. Each microphone and/or microphone accessory is designed for specific applications that serve multiple purposes, so even if you don't have each one of the microphones or accessories listed, read through each description and you may find an idea or more helpful information that allows you to work smarter, not harder.

2. How It Works

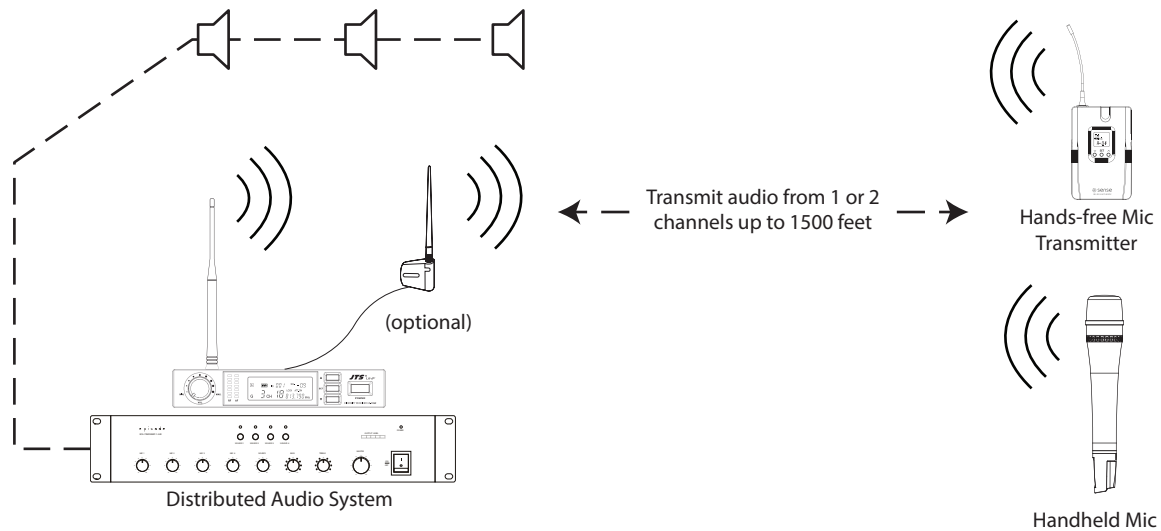

The wireless receiver can be placed on a surface or mounted in a rack. The antennas can be mounted in the front, rear, or extended with an antenna booster (sold separately) for wireless sound pick up from a handheld microphone transmitter or a hands-free body pack (see below for full list of accessories). The SE-300-WR-1CHD receives transmissions up to 1500 feet, then outputs into a distributed audio system.

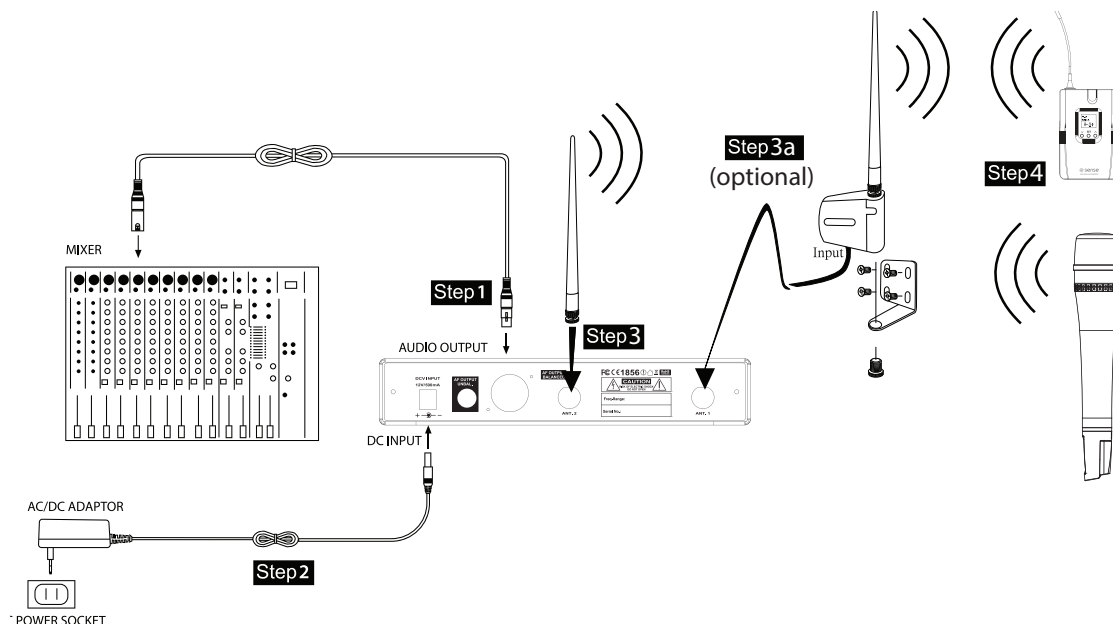

There are just a few steps to take in order to have a proper setup with your Sense microphones.

- Step 1. First, connect the wireless receiver to the mixer.
- Step 2. Connect the two included antennas or add an antenna booster for installations where optimal signal strength is necessary.
- Step 3. Connect the power adapter to the receiver (included), and into a surge protected power outlet.
- Step 4. The last necessary step is to match the frequencies on each transmitting device. This basic setup can be repeated for multiple microphones and applied many times over.



3. Compatible Accessories



Hand-Held Wireless Transmitter and Microphone

The SE-300-WT-HAND (sold separately) transmits connected microphones via wireless signal in corporate presentations, houses of worship, audio/video conferencing, and more. The hand-held wireless transmitter includes colored endcaps, batteries, and a mic stand adapter.

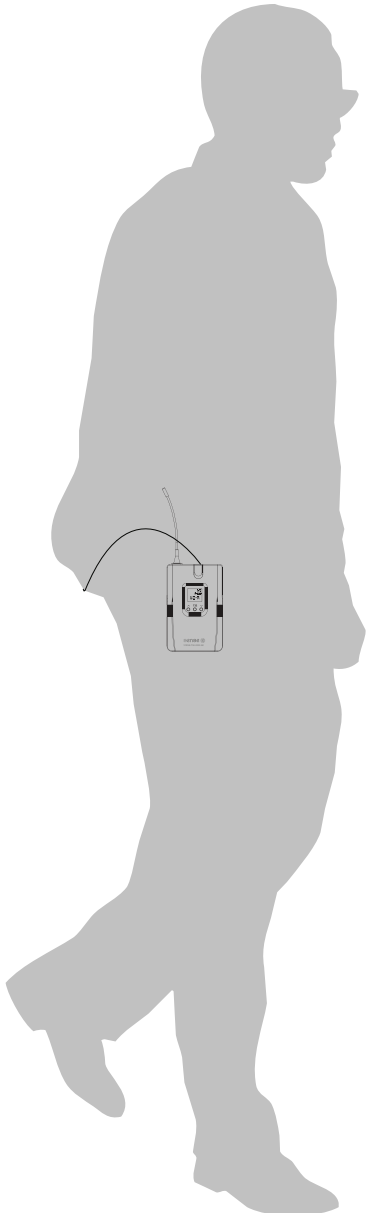

Body-Pack Transmitter

Pair the SE-300-WT-BODY (sold separately) with any of the following three Sense microphones to wirelessly transmit excellent sound reproduction back to the wireless receiver. The hands-free body-pack transmitter includes batteries and a lavalier microphone.

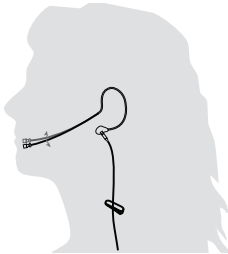

Single Ear Headset Microphone

The SE-500-SEH-T (sold separately) is recommended for speakers in corporate presentations, houses of worship, audio/video conferencing, etc.

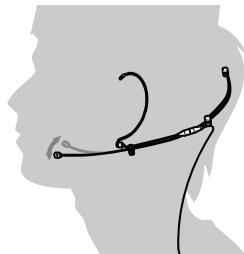

Double Ear Headset Microphone

For animated speakers, the stability and flexibility of the SE-500-DEH-T (sold separately) is ideal for use in corporate presentations, houses of worship, audio/video conferencing, etc.

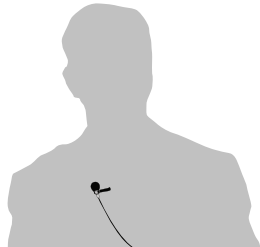

Lavalier Microphone

The traditionally worn SE-300-LAV-BLK (sold with body-pack transmitter or sold separately) lavalier microphone is perfect for corporate presentations, houses of worship, audio/video conferencing, and more.

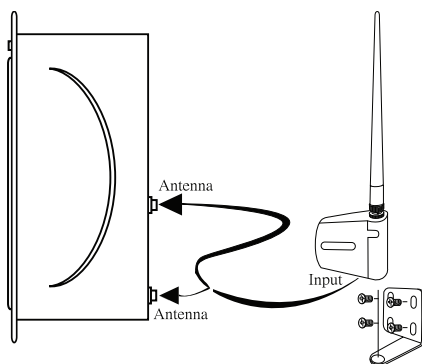

Antenna Booster

Raise your signal strength by 10dB with the SE-ANT-BM. Mount the antennas to a wall or ceiling for an even greater signal pickup. Extend it further with the B-ANT-EXT-20M (also sold separately).

Single Rack Mount

The single rack mount is included with Wireless Receiver. Secure the SE-300-WR-1CHD with 4 screws and secure the mount to the rack with 4 more screws. If desired, thread the antennas to the front rack ears.

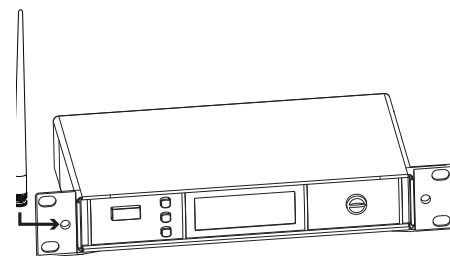

4. Rack Mounting

Installation with Single Rack Mount

- Verify no cords are attached to the receiver. Turn over the rack adapter and receiver. Insert the receiver into the desired rack adapter slot.
- Align, insert, and thread 4 included M3 screws into the 4 mounting holes of the rack adapter and receiver.
- Mount the rack adapter to the rack by threading 4 M3 rack screws (not included) into the rack holes.

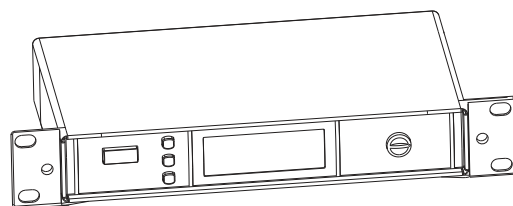



5. Wireless Receiver

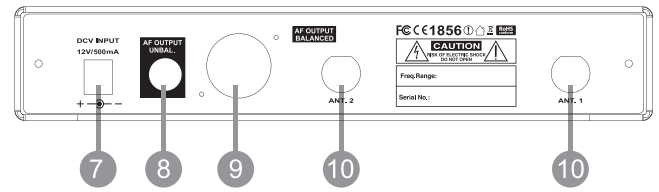
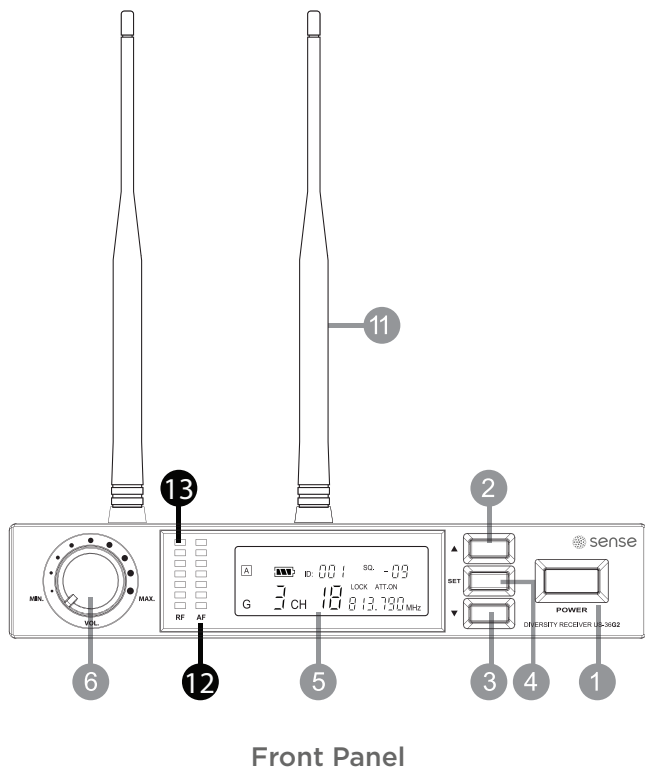

Back Panel

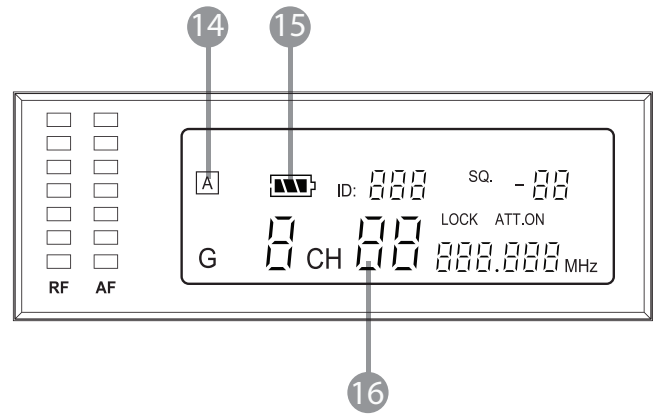

LCD Display

Annotations

- | | |
|--|--|
| <ol style="list-style-type: none"> 1. Power On/Off switch 2. Up button (frequency adjustment) 3. Down button (frequency adjustment) 4. Set button (frequency adjustment) 5. LCD display 6. Volume control 7. DC socket for power adapter 8. AF output, 3mm jack socket (AF UNBAL.) | <ol style="list-style-type: none"> 9. Balanced XLR socket 10. Antenna input socket 11. Antenna 12. AF signal level 13. RF signal level 14. Diversity display (A or B antenna) 15. Battery gauge of the transmitter 16. Channel Display |
|--|--|



6. Wireless Transmitter and Receiver Adjustments

The most important step is pairing the wireless receiver and transmitter's frequency. The wireless receiver, body-pack transmitter, and hand-held wireless transmitter's setup menus function identically. Each device has a SET, UP, and DOWN button to make adjustments to the frequency, group, sensitivity, or pickup gain.

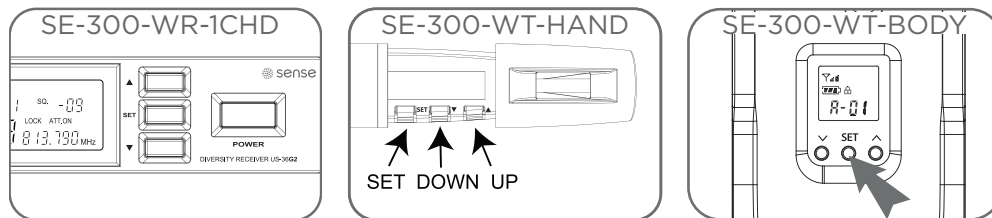

Frequency Pairing

Match the frequency on both the transmitter and the receiver for wireless communication.

- Push the SET button once to select between frequency / group / sensitivity / RF outputs.
- Push the UP or DOWN button to adjust the setting of a menu.
- Press and hold SET for 3 seconds to activate that frequency.
- Once you see “MHz” blinking, you are ready to select your desired frequency by using the UP and DOWN buttons.
- Push SET again to save the setting.

Group Adjusting

Multiple microphones can transmit on the same frequency using matching groups.

- Press SET for 3 seconds, the group (G) will flash on the LCD display.
- Push UP or DOWN to select a desired group.
- Push SET again and the Channel (CH) will flash.
- Push UP or DOWN to select the desired channel.
- Push SET again to save the setting.

Sensitivity Adjusting

Optimize sound pick up by adjusting the sensitivity. *Caution: Increasing sensitivity can cause system feedback.*

- Press the SET button twice to select the sensitivity by holding it down for 3 seconds, releasing, and pressing again for 1 second. The display will show “SEN 12”.
- Use the UP and DOWN buttons to make the necessary adjustments.
- Push SET again to save the setting.

RF Outputs

To adjust the transmission gain, select between low or high. For extended battery life, select “rF Lo”.

- Push the SET button several times until the “rF Lo” or “rF Hi” flashes.
- Push UP to choose “Hi” for high transmitting power (50mW) and push DOWN to choose “Lo” for transmitting power (10mW).
- Push SET again to save the setting.



7. Body-pack Transmitter (Sold Separately)

The SE-300-WT-BODY transmits sound via wireless signal used for corporate presentations, houses of worship, audio/video conferencing, video, film and sound reinforcement, or other applications where low-profile, discreet placement is preferred.

Features

- Phase-locked Loop (PLL) synthesized tuner ensures reliable performance
- Powered by 2 x AA batteries with 12 hrs. battery life
- Equipped with 4-Pin Mini XLR connector
- LCD display with channel and battery life indicator
- The “lock-on” function prevents tampering and RF interruption
- Extended dynamic range and smooth frequency response

Installation Tips & Guidelines

After placing batteries inside the SE-300-WT-BODY and attaching the microphone, pair the wireless frequency with the wireless receiver. Refer to section 5 for full instructions on how to pair the frequency.

Annotations

1. LCD display
2. Battery tray
3. Set button: set the configuration of the bodypack transmitter
4. Up button: To select settings
5. Down button: To select settings
6. Power switch/mute
7. 4-pin Mini-XLR mic. input
8. Antenna
9. Belt Clip
10. Battery status display
11. Group & Channel

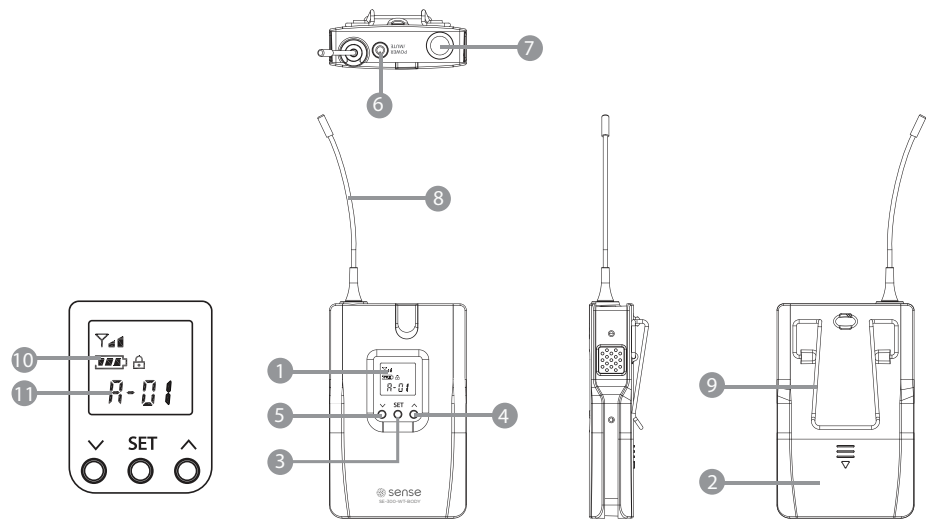



8. Handheld Microphone (Sold Separately)

The SE-300-WT-HAND transmits connected microphones via wireless signal and is typically used for corporate presentations, houses of worship, audio/video conferencing, video, film and sound reinforcement, etc.

Features

- Phase-locked Loop (PLL) synthesized tuner ensures reliable performance
- Powered by 2 x AA batteries with 12 hrs. battery life
- LCD display with channel and battery life indicator
- Advanced circuitry ensures stable signal transmission
- Extended dynamic range and smooth frequency response
- Noise mute and tone-key squelch
- Internal antenna design

Installation Tips & Guidelines

To place or replace batteries inside the SE-300-WT-HAND by taking the following steps.

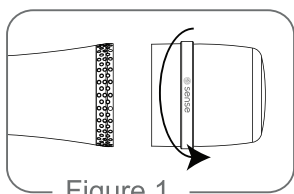

Figure 1

Loosen the microphone head counter-clockwise.

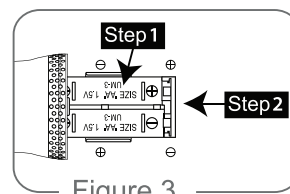

Figure 3

Insert 2 AA batteries. Push the battery tray back into the housing.

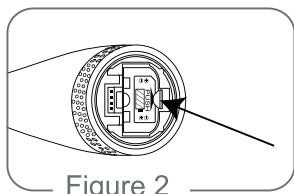

Figure 2

Push both battery tray buttons to release the battery.

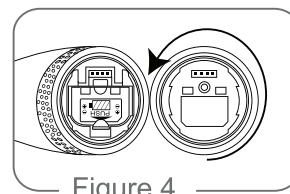
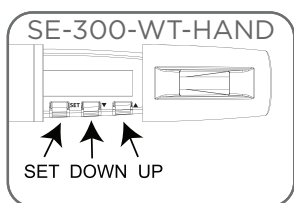

Figure 4

Thread the microphone back on by twisting the head clockwise.

Once you have re-attached the microphone head, pair the wireless frequency with the wireless receiver's frequency. Refer to section 5 for full instructions on how to pair the frequency.

Annotations



Open the bottom of the microphone to access the LCD panel.

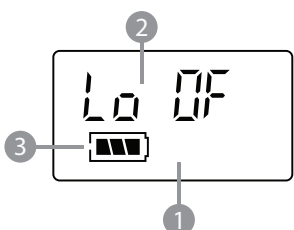

1. LCD Panel
2. Main display
3. Battery Indicator



9. Headset Microphones

Sense attachable headset microphones have an intuitive installation and work great for corporate presentations, houses of worship, audio/video conferencing, and other applications where low-profile, discreet placement is preferred.

Features

- Low-profile design provides unobtrusive pickup
- Durable, flexible material allows for custom fit
- Highly sensitive, omni-directional capsule
- Natural skin tone blends in seamlessly
- Collar clip adds stability

Installation Tips & Guidelines

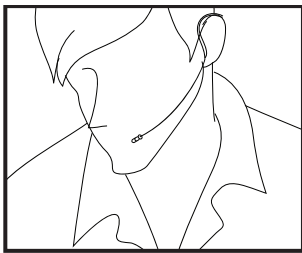

- Adjust the gooseneck of the mic so that it is about 1/2" away from the mouth.
- Do not bend the boom past a 20° angle.

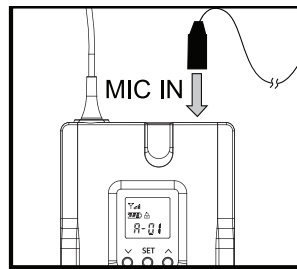

- Connect the 4 pin mini-XLR cable into the "MIC IN" of the body pack.

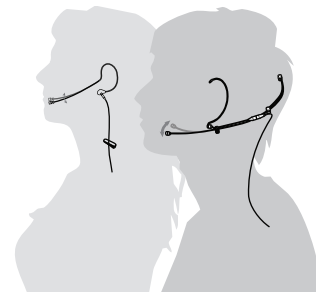

- Attach the detachable cable clip to wherever feels comfortable, such as your back or collar, keeping the cord out of the way.

Single Ear Headset Microphone

To contour the Single Ear Headset Microphone for your face, gently bend the earpiece into a shape that securely grasps the ear. Then gently bend the boom so that it follows the face and the microphone is positioned close to the mouth.

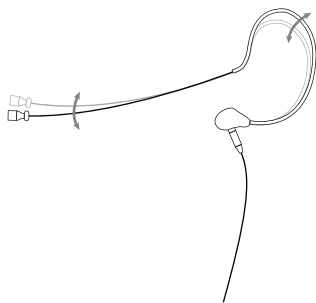

Double Ear Headset Microphone

To contour the Dual Ear Headset Microphone for your face, you will need to adjust the size and bend it into the proper shape. Loosen the adjustment screws, pull the headset to the correct size, then re-tighten the screws to lock the positions in place. Next, gently bend the headset in various locations to create the ideal fit.

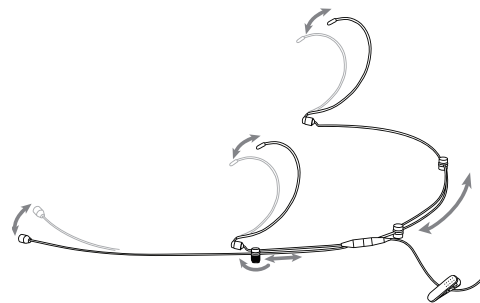



10. Lavalier Microphone (included with Body-Pack)

Sense lavalier microphones have an intuitive installation and work great for corporate presentations, houses of worship, audio/video conferencing, video, film and sound reinforcement, and other applications where low-profile, discreet placement is preferred.

Features

- Low-profile design provides unobtrusive pickup
- Wide dynamic range and frequency response for excellent sound reinforcement
- Omni-directional pickup pattern for various applications
- Included clip for securing to clothing.

Installation Tips & Guidelines

- Attach lavalier microphone to a tie, lapel, or wherever is suitable and about 6-10" away from your face.
- Plug the female, 4-pin mini-XLR cable connector into the "MIC IN" of the body pack.

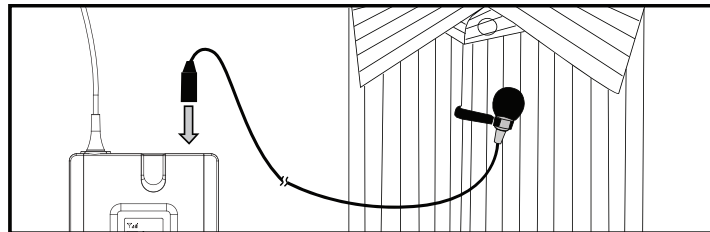

Important Note: Due to the distance between the talker's mouth and the microphone, lavalier microphones are not designed for use in spaces where the talker is being reinforced in the same room - such as training rooms. Using them in these applications will often result in feedback due to the higher gain necessary for proper pickup. For these applications, the single ear hook and double ear hook microphones are recommended.



11. Specifications

SE-300-WR-1CHD			
Frequency Preparation	PLL Synthesized Control		
Carrier Frequency Range	502-960 MHz		
S/N Ratio	>105dB		
T.H.D	<0.6%@1KHz		
Audio Output Level	-12dB		
Controls	Power On/Off, Frequency Up/Down, Lock-on,		
AF Output Impedance	600Ω		
Squelch	Pilot Tone & Noise Mute		
Operation Voltage	12-18 VDC, 200mA		
Output Connector	1 XLR Balanced Socket 1/4" unbalanced phone jack		
Dimensions	212.3mm(W) * 38.3mm(H) * 144mm(D)		
Antennas	Dual Half-wave		
Included Accessories	1U Rack Ears w/ Antenna Mounts, Power Supply		
SE-300-WT-BODY		SE-300-WT-HAND	
Frequency Preparation	PLL Synthesized Control	PLL Synthesized Control	PLL Synthesized Control
Carrier Frequency Range	502-960 MHz	502-960 MHz	502-960 MHz
RF Outputs	10mW / 50mW	10mW / 50mW	10mW / 50mW
Output connector	4-pin mini-XLR (M)	-	-
Stability	±10KHz	±10KHz	±10KHz
Frequency Deviation	±48KHz	±48KHz	±48KHz
LCD Display	Frequency, Battery Level, Sensitivity	Frequency, Battery Level, Sensitivity	Frequency, Battery Level, Sensitivity
Controls	Power On/Off, Mode Setting, AF Level, Frequency Up/Down, Lock-on Mode	Power On/Off, Mode Setting, AF Level, Frequency Up/Down, Lock-on Mode	Power On/Off, Mode Setting, AF Level, Frequency Up/Down, Lock-on Mode
Spurious Emissions	<50 dBC	<50 dBC	<50 dBC
Audio Frequency Response	50-18,000 Hz	50-16,000 Hz	50-16,000 Hz
Battery	(2) AA 1.5V	(2) AA 1.5V	(2) AA 1.5V
Included Accessories	Lavalier Mic, Batteries	Colored Endcaps, Batteries, Mic Stand Adapter	Colored Endcaps, Batteries, Mic Stand Adapter
SE-500-SEH-T, SE-500-DEH-T		SE-300-LAV-BLK	
Connector	4-pin mini-XLR (F)	4-pin mini-XLR (F)	4-pin mini-XLR (F)
Frequency Response	60-15,000Hz	60-15,000Hz	60-15,000Hz
Polar Pattern	Omni-directional	Omni-directional	Omni-directional
Sensitivity (at 1KHz)	-64±3 dB* (0.63mV)	-60±3 dB* (1mV)	-60±3 dB* (1mV)
Impedance	1.8kΩ	2.2kΩ	2.2kΩ
Max. SPL for 1% THD	130dB	130dB	130dB
SE-ANT-BM			
Carrier Frequency Range	470-870 Mhz		
Antenna Gain	1.8 dBi		
Booster Gain	10 (+2, -1) dB		
Coverage Angle	360°		
Operation Volate	12-18v		
Rating	Indoor/Outdoor (not waterproof)		